

# Technical Information

## Proline Promass A 200

Coriolis flowmeter



Flowmeter with genuine two-wire technology for accurate measurement of smallest flow quantities

### Application

- Measuring principle operates independently of physical fluid properties such as viscosity or density
- Suitable for applications with the smallest flow quantities in the chemical industry

### Device properties

- Nominal diameter: DN 1 to 4 ( $\frac{1}{24}$  to  $\frac{1}{8}$ " )
- Process pressure: up to 430.9 bar (6 250 psi)
- Medium temperature up to +205 °C (+401 °F)
- Loop-powered technology
- Robust dual-compartment housing
- Plant safety: worldwide approvals (SIL, Haz. area)

### Your benefits

- Space-saving installation – compact, lightweight sensor
- Highest product quality – self-drainable measuring tube design available in all line sizes
- Optimum process safety – resistant to corrosive ambient conditions and internal clogging
- Convenient device wiring – separate connection compartment
- Safe operation – no need to open the device due to display with touch control, background lighting
- Integrated verification – Heartbeat Technology

## Table of contents





<b>About this document</b> . . . . .	<b>4</b>	Climate class . . . . .	37
Symbols . . . . .	4	Degree of protection . . . . .	37
<b>Function and system design</b> . . . . .	<b>5</b>	Vibration resistance . . . . .	37
Measuring principle . . . . .	5	Shock resistance . . . . .	37
Measuring system . . . . .	7	Shock resistance . . . . .	37
Safety . . . . .	7	Interior cleaning . . . . .	37
		Electromagnetic compatibility (EMC) . . . . .	38
<b>Input</b> . . . . .	<b>9</b>	<b>Process</b> . . . . .	<b>38</b>
Measured variable . . . . .	9	Medium temperature range . . . . .	38
Measuring range . . . . .	9	Density . . . . .	38
Operable flow range . . . . .	10	Pressure-temperature ratings . . . . .	38
Input signal . . . . .	10	Sensor housing . . . . .	42
		Rupture disk . . . . .	42
<b>Output</b> . . . . .	<b>10</b>	Flow limit . . . . .	42
Output signal . . . . .	10	Pressure loss . . . . .	43
Signal on alarm . . . . .	12	System pressure . . . . .	43
Load . . . . .	13	Thermal insulation . . . . .	43
Ex connection data . . . . .	14	Heating . . . . .	43
Low flow cut off . . . . .	17	Vibrations . . . . .	44
Galvanic isolation . . . . .	18	<b>Mechanical construction</b> . . . . .	<b>45</b>
Protocol-specific data . . . . .	18	Dimensions in SI units . . . . .	45
		Dimensions in US units . . . . .	55
<b>Power supply</b> . . . . .	<b>19</b>	Weight . . . . .	64
Terminal assignment . . . . .	19	Materials . . . . .	64
Pin assignment, device plug . . . . .	20	Process connections . . . . .	67
Supply voltage . . . . .	20	Surface roughness . . . . .	67
Power consumption . . . . .	21	<b>Operability</b> . . . . .	<b>67</b>
Current consumption . . . . .	21	Operating concept . . . . .	67
Power supply failure . . . . .	21	Languages . . . . .	67
Electrical connection . . . . .	22	Local operation . . . . .	68
Electrical connection . . . . .	25	Remote operation . . . . .	69
Potential equalization . . . . .	28	Service interface . . . . .	71
Terminals . . . . .	28	<b>Certificates and approvals</b> . . . . .	<b>71</b>
Cable entries . . . . .	28	CE mark . . . . .	71
Cable specification . . . . .	28	RCM-tick symbol . . . . .	71
Overvoltage protection . . . . .	28	Functional safety . . . . .	71
		Ex approval . . . . .	71
<b>Performance characteristics</b> . . . . .	<b>29</b>	Sanitary compatibility . . . . .	72
Reference operating conditions . . . . .	29	Pharmaceutical compatibility . . . . .	73
Maximum measured error . . . . .	29	Functional safety . . . . .	73
Repeatability . . . . .	30	HART certification . . . . .	73
Response time . . . . .	31	FOUNDATION Fieldbus certification . . . . .	73
Influence of ambient temperature . . . . .	31	Certification PROFIBUS . . . . .	73
Influence of medium temperature . . . . .	31	Additional certification . . . . .	73
Influence of medium pressure . . . . .	32	Other standards and guidelines . . . . .	74
Design fundamentals . . . . .	32	<b>Ordering information</b> . . . . .	<b>74</b>
		<b>Application packages</b> . . . . .	<b>75</b>
<b>Installation</b> . . . . .	<b>33</b>	Diagnostics functions . . . . .	75
Mounting location . . . . .	33	Heartbeat Technology . . . . .	75
Orientation . . . . .	33	Special density . . . . .	75
Inlet and outlet runs . . . . .	34		
Special mounting instructions . . . . .	34		
<b>Environment</b> . . . . .	<b>37</b>		
Ambient temperature range . . . . .	37		
Storage temperature . . . . .	37		

<b>Accessories</b> . . . . .	<b>76</b>
Device-specific accessories . . . . .	76
Communication-specific accessories . . . . .	77
Service-specific accessories . . . . .	78
System components . . . . .	78
<b>Supplementary documentation</b> . . . . .	<b>79</b>
Standard documentation . . . . .	79
Supplementary device-dependent documentation . . . . .	79
<b>Registered trademarks</b> . . . . .	<b>80</b>

## About this document

### Symbols









#### Electrical symbols

Symbol	Meaning
	Direct current
	Alternating current
	Direct current and alternating current
	<b>Ground connection</b> A grounded terminal which, as far as the operator is concerned, is grounded via a grounding system.
	<b>Protective Earth (PE)</b> A terminal which must be connected to ground prior to establishing any other connections.  The ground terminals are situated inside and outside the device: <ul style="list-style-type: none"> <li>▪ Inner ground terminal: Connects the protective earth to the mains supply.</li> <li>▪ Outer ground terminal: Connects the device to the plant grounding system.</li> </ul>

#### Communication symbols



Symbol	Meaning
	<b>Wireless Local Area Network (WLAN)</b> Communication via a wireless, local network.

#### Symbols for certain types of information

Symbol	Meaning
	<b>Permitted</b> Procedures, processes or actions that are permitted.
	<b>Preferred</b> Procedures, processes or actions that are preferred.
	<b>Forbidden</b> Procedures, processes or actions that are forbidden.
	<b>Tip</b> Indicates additional information.
	Reference to documentation.
	Reference to page.
	Reference to graphic.
	Visual inspection.

#### Symbols in graphics

Symbol	Meaning
1, 2, 3, ...	Item numbers
<b>1</b> , <b>2</b> , <b>3</b> , ...	Series of steps
A, B, C, ...	Views
A-A, B-B, C-C, ...	Sections

Symbol	Meaning
	Hazardous area
	Safe area (non-hazardous area)
	Flow direction

## Function and system design

### Measuring principle

The measuring principle is based on the controlled generation of Coriolis forces. These forces are always present in a system when both translational and rotational movements are superimposed.

$$F_c = 2 \cdot \Delta m (v \cdot \omega)$$

$F_c$  = Coriolis force

$\Delta m$  = moving mass

$\omega$  = rotational velocity

$v$  = radial velocity in rotating or oscillating system

The amplitude of the Coriolis force depends on the moving mass  $\Delta m$ , its velocity  $v$  in the system and thus on the mass flow. Instead of a constant rotational velocity  $\omega$ , the sensor uses oscillation.

In the sensor, an oscillation is produced in the measuring tube. The Coriolis forces produced at the measuring tube cause a phase shift in the tube oscillations (see illustration):

- If there is zero flow (i.e. when the fluid stands still), the oscillation measured at points A and B has the same phase (no phase difference) (1).
- Mass flow causes deceleration of the oscillation at the inlet of the tubes (2) and acceleration at the outlet (3).

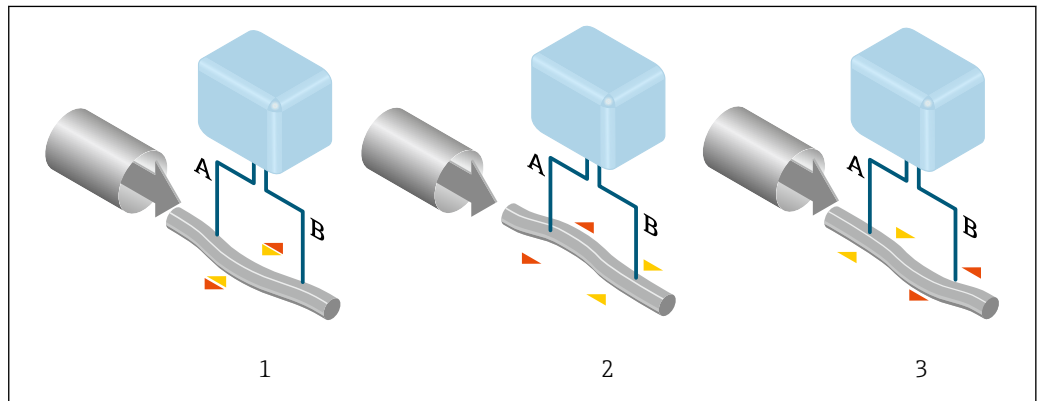

The phase difference (A-B) increases with increasing mass flow. Electrodynamic sensors register the tube oscillations at the inlet and outlet. The measuring principle operates independently of temperature, pressure, viscosity, conductivity and flow profile.

### Density measurement

The measuring tube is continuously excited at its resonance frequency. A change in the mass and thus the density of the oscillating system (comprising measuring tube and fluid) results in a corresponding, automatic adjustment in the oscillation frequency. Resonance frequency is thus a function of medium density. The microprocessor utilizes this relationship to obtain a density signal.

### Volume measurement

Together with the measured mass flow, this is used to calculate the volume flow.

**Temperature measurement**

The temperature of the measuring tube is determined in order to calculate the compensation factor due to temperature effects. This signal corresponds to the process temperature and is also available as an output signal.

**Measuring system**

The device consists of a transmitter and a sensor.  
 The device is available as a compact version:  
 The transmitter and sensor form a mechanical unit.

**Transmitter**

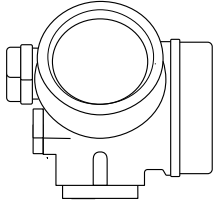
<p><b>Proline 200</b></p>  <p style="text-align: right; font-size: small;">A0013471</p>	<p>Device versions and materials:</p> <ul style="list-style-type: none"> <li>■ Compact, aluminum coated: Aluminum, AlSi10Mg, coated</li> <li>■ Compact or remote version, stainless: For maximum corrosion resistance: stainless steel CF3M</li> </ul> <p>Configuration:</p> <ul style="list-style-type: none"> <li>■ External operation via four-line, illuminated local display with touch control and guided menus ("Make-it-run" wizards) for applications</li> <li>■ Via operating tools (e.g. FieldCare)</li> </ul>
--	---

**Sensor**

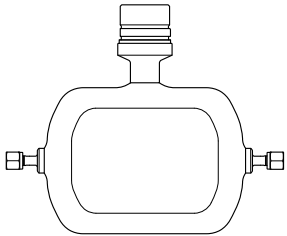
<p><b>Promass A</b></p>  <p style="text-align: right; font-size: small;">A0036494</p>	<ul style="list-style-type: none"> <li>■ Bent single-tube system for high-precision measurement of minimum flow rates</li> <li>■ Simultaneous measurement of flow, volume flow, density and temperature (multivariable)</li> <li>■ Immune to process influences</li> <li>■ Nominal diameter range: DN 1 to 4 (1/24 to 1/8 ")</li> <li>■ Materials:                         <ul style="list-style-type: none"> <li>■ Sensor: stainless steel, 1.4404 (316/316L)</li> <li>■ Measuring tube: stainless steel, 1.4435 (316/316L); Alloy C22, 2.4602 (UNS N06022)</li> <li>■ Process connections: stainless steel, 1.4404 (316/316L); 1.4435 (316L); Alloy C22, 2.4602 (UNS N06022)</li> </ul> </li> </ul>
---	---

**Safety**

**IT security**

Our warranty is valid only if the device is installed and used as described in the Operating Instructions. The device is equipped with security mechanisms to protect it against any inadvertent changes to the settings.

IT security measures, which provide additional protection for the device and associated data transfer, must be implemented by the operators themselves in line with their security standards.

**Device-specific IT security**

The device offers a range of specific functions to support protective measures on the operator's side. These functions can be configured by the user and guarantee greater in-operation safety if used correctly. An overview of the most important functions is provided in the following section.

*Protecting access via hardware write protection*

Write access to the device parameters via the local display or operating tool (e.g. FieldCare, DeviceCare) can be disabled via a write protection switch (DIP switch on the motherboard). When hardware write protection is enabled, only read access to the parameters is possible.

Hardware write protection is disabled when the device is delivered.

*Protecting access via a password*

A password can be used to protect against write access to the device parameters.

This password locks write access to the device parameters via the local display or another operating tool (e.g. FieldCare, DeviceCare) and, in terms of functionality, is equivalent to hardware write protection. If the service interface CDI RJ-45 is used, read access is only possible if the password is entered.

*User-specific access code*

Write access to the device parameters via the local display or operating tool (e.g. FieldCare, DeviceCare) can be protected by the modifiable, user-specific access code.

*Access via fieldbus*

Cyclic fieldbus communication (read and write, e.g. measured value transmission) with a higher-order system is not affected by the restrictions mentioned above.



# Input

<b>Measured variable</b>	<b>Direct measured variables</b>
	<ul style="list-style-type: none"> <li>■ Mass flow</li> <li>■ Density</li> <li>■ Temperature</li> </ul>
	<b>Calculated measured variables</b>
	<ul style="list-style-type: none"> <li>■ Volume flow</li> <li>■ Corrected volume flow</li> <li>■ Reference density</li> </ul>

<b>Measuring range</b>	<b>Measuring range for liquids</b>			
	<b>DN</b>		<b>Measuring range full scale values <math>\dot{m}_{\min(F)}</math> to <math>\dot{m}_{\max(F)}</math></b>	
	<b>[mm]</b>	<b>[in]</b>	<b>[kg/h]</b>	<b>[lb/min]</b>
	1	1/24	0 to 20	0 to 0.735
	2	1/12	0 to 100	0 to 3.675
	4	1/8	0 to 450	0 to 16.54



### Measuring range for gases

The full scale value depends on the density and the sound velocity of the gas used and can be calculated with the formula below:

$$\dot{m}_{\max(G)} = \text{minimum} (\dot{m}_{\max(F)} \cdot \rho_G : x ; \rho_G \cdot c_G \cdot \pi/2 \cdot (d_i)^2 \cdot 3600)$$

$\dot{m}_{\max(G)}$	Maximum full scale value for gas [kg/h]
$\dot{m}_{\max(F)}$	Maximum full scale value for liquid [kg/h]
$\dot{m}_{\max(G)} < \dot{m}_{\max(F)}$	$\dot{m}_{\max(G)}$ can never be greater than $\dot{m}_{\max(F)}$
$\rho_G$	Gas density in [kg/m <sup>3</sup> ] at operating conditions
$x$	Constant dependent on nominal diameter
$c_G$	Sound velocity (gas) [m/s]
$d_i$	Measuring tube internal diameter [m]

<b>DN</b>		<b>x</b>
<b>[mm]</b>	<b>[in]</b>	<b>[kg/m<sup>3</sup>]</b>
1	1/24	32
2	1/12	32
4	1/8	32

 To calculate the measuring range, use the *Applicator* sizing tool →  78



### Calculation example for gas

- Sensor: Promass A, DN 2
- Gas: Air with a density of 11.9 kg/m<sup>3</sup> (at 20 °C and 10 bar)
- Measuring range (liquid): 100 kg/h
- $x = 32 \text{ kg/m}^3$  (for Promass A DN 2)

Maximum possible full scale value:

$$\dot{m}_{\max(G)} = \dot{m}_{\max(F)} \cdot \rho_G : x = 100 \text{ kg/h} \cdot 11.9 \text{ kg/m}^3 : 32 \text{ kg/m}^3 = 37.2 \text{ kg/h}$$

**Recommended measuring range**

 Flow limit →  42



**Operable flow range**

Over 1000 : 1.

Flow rates above the preset full scale value do not override the electronics unit, with the result that the totalizer values are registered correctly.

**Input signal****External measured values**

To increase the accuracy of certain measured variables or to calculate the corrected volume flow for gases, the automation system can continuously write the operating pressure to the measuring device. Endress+Hauser recommends the use of a pressure measuring device for absolute pressure, e.g. Cerabar M or Cerabar S.

 Various pressure transmitters and temperature measuring devices can be ordered from Endress +Hauser: see "Accessories" section →  78

It is recommended to read in external measured values to calculate the following measured variables:

- Mass flow
- Corrected volume flow

*HART protocol*

The measured values are written from the automation system to the measuring device via the HART protocol. The pressure transmitter must support the following protocol-specific functions:

- HART protocol
- Burst mode

*Digital communication*

The measured values can be written from the automation system to the measuring via:



- FOUNDATION Fieldbus
- PROFIBUS PA

## Output

**Output signal****Current output**

<b>Current output 1</b>	4-20 mA HART (passive)
<b>Current output 2</b>	4-20 mA (passive)
<b>Resolution</b>	< 1 $\mu$ A
<b>Damping</b>	Adjustable: 0.0 to 999.9 s
<b>Assignable measured variables</b>	<ul style="list-style-type: none"> <li>▪ Mass flow</li> <li>▪ Volume flow</li> <li>▪ Corrected volume flow</li> <li>▪ Density</li> <li>▪ Reference density</li> <li>▪ Temperature</li> </ul>

**Pulse/frequency/switch output**

<b>Function</b>	Can be set to pulse, frequency or switch output
<b>Version</b>	Passive, open collector
<b>Maximum input values</b>	<ul style="list-style-type: none"> <li>▪ DC 35 V</li> <li>▪ 50 mA</li> </ul> <p> For information on the Ex connection values →  14</p>

<b>Voltage drop</b>	<ul style="list-style-type: none"> <li>▪ For ≤ 2 mA: 2 V</li> <li>▪ For 10 mA: 8 V</li> </ul>
<b>Residual current</b>	≤ 0.05 mA
<b>Pulse output</b>	
<b>Pulse width</b>	Adjustable: 5 to 2 000 ms
<b>Maximum pulse rate</b>	100 Impulse/s
<b>Pulse value</b>	Adjustable
<b>Assignable measured variables</b>	<ul style="list-style-type: none"> <li>▪ Mass flow</li> <li>▪ Volume flow</li> <li>▪ Corrected volume flow</li> </ul>
<b>Frequency output</b>	
<b>Output frequency</b>	Adjustable: 0 to 1 000 Hz
<b>Damping</b>	Adjustable: 0 to 999 s
<b>Pulse/pause ratio</b>	1:1
<b>Assignable measured variables</b>	<ul style="list-style-type: none"> <li>▪ Mass flow</li> <li>▪ Volume flow</li> <li>▪ Corrected volume flow</li> <li>▪ Density</li> <li>▪ Reference density</li> <li>▪ Temperature</li> </ul>
<b>Switch output</b>	
<b>Switching behavior</b>	Binary, conductive or non-conductive
<b>Switching delay</b>	Adjustable: 0 to 100 s
<b>Number of switching cycles</b>	Unlimited
<b>Assignable functions</b>	<ul style="list-style-type: none"> <li>▪ Off</li> <li>▪ On</li> <li>▪ Diagnostic behavior</li> <li>▪ Limit value                             <ul style="list-style-type: none"> <li>▪ Mass flow</li> <li>▪ Volume flow</li> <li>▪ Corrected volume flow</li> <li>▪ Density</li> <li>▪ Reference density</li> <li>▪ Temperature</li> </ul> </li> <li>▪ Totalizer 1-3</li> <li>▪ Flow direction monitoring</li> <li>▪ Status                             <ul style="list-style-type: none"> <li>▪ Partially filled pipe detection</li> <li>▪ Low flow cut off</li> </ul> </li> </ul>

#### FOUNDATION Fieldbus

<b>FOUNDATION Fieldbus</b>	H1, IEC 61158-2, galvanically isolated
<b>Data transfer</b>	31.25 kbit/s
<b>Current consumption</b>	18 mA
<b>Permitted supply voltage</b>	9 to 32 V
<b>Bus connection</b>	With integrated reverse polarity protection

#### PROFIBUS PA

<b>PROFIBUS PA</b>	In accordance with EN 50170 Volume 2, IEC 61158-2 (MBP), galvanically isolated
<b>Data transmission</b>	31.25 kbit/s

<b>Current consumption</b>	16 mA
<b>Permitted supply voltage</b>	9 to 32 V
<b>Bus connection</b>	With integrated reverse polarity protection

**Signal on alarm**

Depending on the interface, failure information is displayed as follows:

**Current output 4 to 20 mA**

*4 to 20 mA*

<b>Failure mode</b>	Choose from: <ul style="list-style-type: none"> <li>■ 4 to 20 mA in accordance with NAMUR recommendation NE 43</li> <li>■ 4 to 20 mA in accordance with US</li> <li>■ Min. value: 3.59 mA</li> <li>■ Max. value: 22.5 mA</li> <li>■ Freely definable value between: 3.59 to 22.5 mA</li> <li>■ Actual value</li> <li>■ Last valid value</li> </ul>
---------------------	--

**Pulse/frequency/switch output**

<b>Pulse output</b>	
<b>Failure mode</b>	Choose from: <ul style="list-style-type: none"> <li>■ Actual value</li> <li>■ No pulses</li> </ul>
<b>Frequency output</b>	
<b>Failure mode</b>	Choose from: <ul style="list-style-type: none"> <li>■ Actual value</li> <li>■ 0 Hz</li> <li>■ Defined value: 0 to 1250 Hz</li> </ul>
<b>Switch output</b>	
<b>Failure mode</b>	Choose from: <ul style="list-style-type: none"> <li>■ Current status</li> <li>■ Open</li> <li>■ Closed</li> </ul>

**FOUNDATION Fieldbus**

<b>Status and alarm messages</b>	Diagnostics in accordance with FF-891
<b>Failure current FDE (Fault Disconnection Electronic)</b>	0 mA

**PROFIBUS PA**

<b>Status and alarm messages</b>	Diagnostics in accordance with PROFIBUS PA Profile 3.02
<b>Failure current FDE (Fault Disconnection Electronic)</b>	0 mA

**Local display**



<b>Plain text display</b>	With information on cause and remedial measures
<b>Backlight</b>	Additionally for device version with SD03 local display: red lighting indicates a device error.

 Status signal as per NAMUR recommendation NE 107

**Interface/protocol**

- Via digital communication:
  - HART protocol
  - FOUNDATION Fieldbus
  - PROFIBUS PA
- Via service interface
  - CDI service interface

<b>Plain text display</b>	With information on cause and remedial measures
---------------------------	---

 Additional information on remote operation →  69

**Load**

Load for current output: 0 to 500 Ω, depending on the external supply voltage of the power supply unit

**Calculation of the maximum load**

Depending on the supply voltage of the power supply unit ( $U_S$ ), the maximum load ( $R_B$ ) including line resistance must be observed to ensure adequate terminal voltage at the device. In doing so, observe the minimum terminal voltage

- For  $U_S = 17.9$  to  $18.9$  V:  $R_B \leq (U_S - 17.9$  V): 0.0036 A
- For  $U_S = 18.9$  to  $24$  V:  $R_B \leq (U_S - 13$  V): 0.022 A
- For  $U_S = \geq 24$  V:  $R_B \leq 500$  Ω

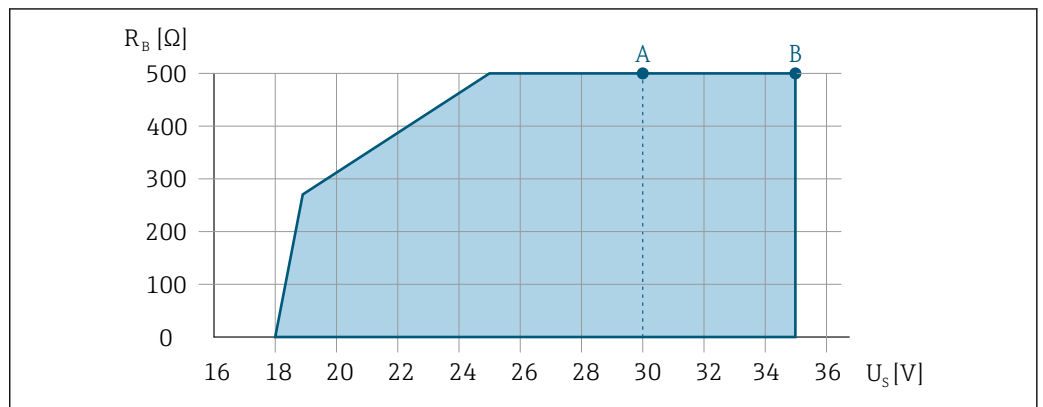

- A Operating range for order code for "Output", option A "4-20 mA HART"/option B "4-20 mA HART, pulse/frequency/switch output" with Ex i and option C "4-20 mA HART + 4-20 mA analog"
- B Operating range for order code for "Output", option A "4-20 mA HART"/option B "4-20 mA HART, pulse/frequency/switch output" with non-Ex and Ex d

**Sample calculation**

Supply voltage of power supply unit:  $U_S = 19$  V  
 Maximum load:  $R_B \leq (19$  V - 13 V): 0.022 A = 273 Ω

## Ex connection data

## Safety-related values

Type of protection Ex d

Order code for "Output"	Output type	Safety-related values
Option A	4-20mA HART	$U_{nom} = DC 35 V$ $U_{max} = 250 V$
Option B	4-20mA HART	$U_{nom} = DC 35 V$ $U_{max} = 250 V$
	Pulse/frequency/switch output	$U_{nom} = DC 35 V$ $U_{max} = 250 V$ $P_{max} = 1 W^{1)}$
Option C	4-20mA HART	$U_{nom} = DC 30 V$ $U_{max} = 250 V$
	4-20mA analog	
Option E	FOUNDATION Fieldbus	$U_{nom} = DC 32 V$ $U_{max} = 250 V$ $P_{max} = 0.88 W$
	Pulse/frequency/switch output	$U_{nom} = DC 35 V$ $U_{max} = 250 V$ $P_{max} = 1 W^{1)}$
Option G	PROFIBUS PA	$U_{nom} = DC 32 V$ $U_{max} = 250 V$ $P_{max} = 0.88 W$
	Pulse/frequency/switch output	$U_{nom} = DC 35 V$ $U_{max} = 250 V$ $P_{max} = 1 W^{1)}$

1) Internal circuit limited by  $R_i = 760.5 \Omega$ 

Type of protection Ex ec Ex nA

Order code for "Output"	Output type	Safety-related values
Option A	4-20mA HART	$U_{nom} = DC 35 V$ $U_{max} = 250 V$
Option B	4-20mA HART	$U_{nom} = DC 35 V$ $U_{max} = 250 V$
	Pulse/frequency/switch output	$U_{nom} = DC 35 V$ $U_{max} = 250 V$ $P_{max} = 1 W^{1)}$
Option C	4-20mA HART	$U_{nom} = DC 30 V$ $U_{max} = 250 V$
	4-20mA analog	
Option E	FOUNDATION Fieldbus	$U_{nom} = DC 32 V$ $U_{max} = 250 V$ $P_{max} = 0.88 W$
	Pulse/frequency/switch output	$U_{nom} = DC 35 V$ $U_{max} = 250 V$ $P_{max} = 1 W$
Option G	PROFIBUS PA	$U_{nom} = DC 32 V$ $U_{max} = 250 V$ $P_{max} = 0.88 W$
	Pulse/frequency/switch output	$U_{nom} = DC 35 V$ $U_{max} = 250 V$ $P_{max} = 1 W$

1) Internal circuit limited by  $R_i = 760.5 \Omega$

Type of protection *XP*

Order code for "Output"	Output type	Safety-related values
Option A	4-20mA HART	$U_{nom} = DC 35 V$ $U_{max} = 250 V$
Option B	4-20mA HART	$U_{nom} = DC 35 V$ $U_{max} = 250 V$
	Pulse/frequency/switch output	$U_{nom} = DC 35 V$ $U_{max} = 250 V$ $P_{max} = 1 W^{1)}$
Option C	4-20mA HART	$U_{nom} = DC 30 V$ $U_{max} = 250 V$
	4-20mA analog	
Option E	FOUNDATION Fieldbus	$U_{nom} = DC 32 V$ $U_{max} = 250 V$ $P_{max} = 0.88 W$
	Pulse/frequency/switch output	$U_{nom} = DC 35 V$ $U_{max} = 250 V$ $P_{max} = 1 W^{1)}$
Option G	PROFIBUS PA	$U_{nom} = DC 32 V$ $U_{max} = 250 V$ $P_{max} = 0.88 W$
	Pulse/frequency/switch output	$U_{nom} = DC 35 V$ $U_{max} = 250 V$ $P_{max} = 1 W^{1)}$

1) Internal circuit limited by  $R_i = 760.5 \Omega$

**Intrinsically safe values**

Type of protection *Ex ia*

Order code for "Output"	Output type	Intrinsically safe values
Option A	4-20mA HART	$U_i = DC 30 V$ $I_i = 300 mA$ $P_i = 1 W$ $L_i = 0 \mu H$ $C_i = 5 nF$
Option B	4-20mA HART	$U_i = DC 30 V$ $I_i = 300 mA$ $P_i = 1 W$ $L_i = 0 \mu H$ $C_i = 5 nF$
	Pulse/frequency/switch output	$U_i = DC 30 V$ $I_i = 300 mA$ $P_i = 1 W$ $L_i = 0 \mu H$ $C_i = 6 nF$
Option C	4-20mA HART	$U_i = DC 30 V$ $I_i = 300 mA$ $P_i = 1 W$ $L_i = 0 \mu H$ $C_i = 30 nF$
	4-20mA analog	

Order code for "Output"	Output type	Intrinsically safe values	
Option E	FOUNDATION Fieldbus	STANDARD U <sub>i</sub> = 30 V I <sub>i</sub> = 300 mA P <sub>i</sub> = 1.2 W L <sub>i</sub> = 10 µH C <sub>i</sub> = 5 nF	FISCO U <sub>i</sub> = 17.5 V I <sub>i</sub> = 550 mA P <sub>i</sub> = 5.5 W L <sub>i</sub> = 10 µH C <sub>i</sub> = 5 nF
	Pulse/frequency/switch output	U <sub>i</sub> = 30 V I <sub>i</sub> = 300 mA P <sub>i</sub> = 1 W L <sub>i</sub> = 0 µH C <sub>i</sub> = 6 nF	
Option G	PROFIBUS PA	STANDARD U <sub>i</sub> = 30 V I <sub>i</sub> = 300 mA P <sub>i</sub> = 1.2 W L <sub>i</sub> = 10 µH C <sub>i</sub> = 5 nF	FISCO U <sub>i</sub> = 17.5 V I <sub>i</sub> = 550 mA P <sub>i</sub> = 5.5 W L <sub>i</sub> = 10 µH C <sub>i</sub> = 5 nF
	Pulse/frequency/switch output	U <sub>i</sub> = 30 V I <sub>i</sub> = 300 mA P <sub>i</sub> = 1 W L <sub>i</sub> = 0 µH C <sub>i</sub> = 6 nF	

*Type of protection Ex ic*

Order code for "Output"	Output type	Intrinsically safe values	
Option A	4-20mA HART	U <sub>i</sub> = DC 35 V I <sub>i</sub> = n.a. P <sub>i</sub> = 1 W L <sub>i</sub> = 0 µH C <sub>i</sub> = 5 nF	
Option B	4-20mA HART	U <sub>i</sub> = DC 35 V I <sub>i</sub> = n.a. P <sub>i</sub> = 1 W L <sub>i</sub> = 0 µH C <sub>i</sub> = 5 nF	
	Pulse/frequency/switch output	U <sub>i</sub> = DC 35 V I <sub>i</sub> = n.a. P <sub>i</sub> = 1 W L <sub>i</sub> = 0 µH C <sub>i</sub> = 6 nF	
Option C	4-20mA HART	U <sub>i</sub> = DC 30 V I <sub>i</sub> = n.a. P <sub>i</sub> = 1 W L <sub>i</sub> = 0 µH C <sub>i</sub> = 30 nF	
	4-20mA analog		
Option E	FOUNDATION Fieldbus	STANDARD U <sub>i</sub> = 32 V I <sub>i</sub> = 300 mA P <sub>i</sub> = n.a. L <sub>i</sub> = 10 µH C <sub>i</sub> = 5 nF	FISCO U <sub>i</sub> = 17.5 V I <sub>i</sub> = n.a. P <sub>i</sub> = n.a. L <sub>i</sub> = 10 µH C <sub>i</sub> = 5 nF
	Pulse/frequency/switch output	U <sub>i</sub> = 35 V I <sub>i</sub> = 300 mA P <sub>i</sub> = 1 W L <sub>i</sub> = 0 µH C <sub>i</sub> = 6 nF	



Order code for "Output"	Output type	Intrinsically safe values	
Option G	PROFIBUS PA	STANDARD U <sub>i</sub> = 32 V I <sub>i</sub> = 300 mA P <sub>i</sub> = n.a. L <sub>i</sub> = 10 µH C <sub>i</sub> = 5 nF	FISCO U <sub>i</sub> = 17.5 V I <sub>i</sub> = n.a. P <sub>i</sub> = n.a. L <sub>i</sub> = 10 µH C <sub>i</sub> = 5 nF
	Pulse/frequency/switch output	U <sub>i</sub> = 35 V I <sub>i</sub> = 300 mA P <sub>i</sub> = 1 W L <sub>i</sub> = 0 µH C <sub>i</sub> = 6 nF	

Type of protection IS

Order code for "Output"	Output type	Intrinsically safe values	
Option A	4-20mA HART	U <sub>i</sub> = DC 30 V I <sub>i</sub> = 300 mA P <sub>i</sub> = 1 W L <sub>i</sub> = 0 µH C <sub>i</sub> = 5 nF	
Option B	4-20mA HART	U <sub>i</sub> = DC 30 V I <sub>i</sub> = 300 mA P <sub>i</sub> = 1 W L <sub>i</sub> = 0 µH C <sub>i</sub> = 5 nF	
	Pulse/frequency/switch output	U <sub>i</sub> = DC 30 V I <sub>i</sub> = 300 mA P <sub>i</sub> = 1 W L <sub>i</sub> = 0 µH C <sub>i</sub> = 6 nF	
Option C	4-20mA HART	U <sub>i</sub> = DC 30 V I <sub>i</sub> = 300 mA P <sub>i</sub> = 1 W L <sub>i</sub> = 0 µH C <sub>i</sub> = 30 nF	
	4-20mA analog		
Option E	FOUNDATION Fieldbus	STANDARD U <sub>i</sub> = 30 V I <sub>i</sub> = 300 mA P <sub>i</sub> = 1.2 W L <sub>i</sub> = 10 µH C <sub>i</sub> = 5 nF	FISCO U <sub>i</sub> = 17.5 V I <sub>i</sub> = 550 mA P <sub>i</sub> = 5.5 W L <sub>i</sub> = 10 µH C <sub>i</sub> = 5 nF
	Pulse/frequency/switch output	U <sub>i</sub> = 30 V I <sub>i</sub> = 300 mA P <sub>i</sub> = 1 W L <sub>i</sub> = 0 µH C <sub>i</sub> = 6 nF	
Option G	PROFIBUS PA	STANDARD U <sub>i</sub> = 30 V I <sub>i</sub> = 300 mA P <sub>i</sub> = 1.2 W L <sub>i</sub> = 10 µH C <sub>i</sub> = 5 nF	FISCO U <sub>i</sub> = 17.5 V I <sub>i</sub> = 550 mA P <sub>i</sub> = 5.5 W L <sub>i</sub> = 10 µH C <sub>i</sub> = 5 nF
	Pulse/frequency/switch output	U <sub>i</sub> = 30 V I <sub>i</sub> = 300 mA P <sub>i</sub> = 1 W L <sub>i</sub> = 0 µH C <sub>i</sub> = 6 nF	

**Low flow cut off**

The switch points for low flow cut off are user-selectable.

**Galvanic isolation**

All outputs are galvanically isolated from one another.

**Protocol-specific data****HART**

<b>Manufacturer ID</b>	0x11
<b>Device type ID</b>	0x54
<b>HART protocol revision</b>	7
<b>Device description files (DTM, DD)</b>	Information and files under: <a href="http://www.endress.com">www.endress.com</a>
<b>HART load</b>	<ul style="list-style-type: none"> <li>▪ Min. 250 Ω</li> <li>▪ Max. 500 Ω</li> </ul>
<b>System integration</b>	For information on system integration, see Operating Instructions. <ul style="list-style-type: none"> <li>▪ Measured variables via HART protocol</li> <li>▪ Burst Mode functionality</li> </ul>

**FOUNDATION Fieldbus**

<b>Manufacturer ID</b>	0x452B48
<b>Ident number</b>	0x1054
<b>Device revision</b>	1
<b>DD revision</b>	Information and files under:
<b>CFF revision</b>	<ul style="list-style-type: none"> <li>▪ <a href="http://www.endress.com">www.endress.com</a></li> <li>▪ <a href="http://www.fieldbus.org">www.fieldbus.org</a></li> </ul>
<b>Device Tester Version (ITK version)</b>	6.1.1
<b>ITK Test Campaign Number</b>	IT094200
<b>Link Master capability (LAS)</b>	Yes
<b>Choice of "Link Master" and "Basic Device"</b>	Yes Factory setting: Basic Device
<b>Node address</b>	Factory setting: 247 (0xF7)
<b>Supported functions</b>	The following methods are supported: <ul style="list-style-type: none"> <li>▪ Restart</li> <li>▪ ENP Restart</li> <li>▪ Diagnostic</li> </ul>
<b>Virtual Communication Relationships (VCRs)</b>	
<b>Number of VCRs</b>	44
<b>Number of link objects in VFD</b>	50
<b>Permanent entries</b>	1
<b>Client VCRs</b>	0
<b>Server VCRs</b>	10
<b>Source VCRs</b>	43
<b>Sink VCRs</b>	0
<b>Subscriber VCRs</b>	43
<b>Publisher VCRs</b>	43
<b>Device Link Capabilities</b>	
<b>Slot time</b>	4
<b>Min. delay between PDU</b>	8

<b>Max. response delay</b>	Min. 5
<b>System integration</b>	For information on system integration, see Operating Instructions. <ul style="list-style-type: none"> <li>▪ Cyclic data transmission</li> <li>▪ Description of the modules</li> <li>▪ Execution times</li> <li>▪ Methods</li> </ul>

**PROFIBUS PA**

<b>Manufacturer ID</b>	0x11
<b>Ident number</b>	0x155F
<b>Profile version</b>	3.02
<b>Device description files (GSD, DTM, DD)</b>	Information and files under: <ul style="list-style-type: none"> <li>▪ <a href="http://www.endress.com">www.endress.com</a></li> <li>▪ <a href="http://www.profibus.org">www.profibus.org</a></li> </ul>
<b>Supported functions</b>	<ul style="list-style-type: none"> <li>▪ Identification &amp; Maintenance Simple device identification via control system and nameplate</li> <li>▪ PROFIBUS upload/download Reading and writing parameters is up to ten times faster with PROFIBUS upload/download</li> <li>▪ Condensed status Simplest and self-explanatory diagnostic information by categorizing diagnostic messages that occur</li> </ul>
<b>Configuration of the device address</b>	<ul style="list-style-type: none"> <li>▪ DIP switches on the I/O electronics module</li> <li>▪ Local display</li> <li>▪ Via operating tools (e. g. FieldCare)</li> </ul>
<b>System integration</b>	For information on system integration, see Operating Instructions. <ul style="list-style-type: none"> <li>▪ Cyclic data transmission</li> <li>▪ Block model</li> <li>▪ Description of the modules</li> </ul>

**Power supply**

**Terminal assignment**

**Transmitter**

*Connection versions*

<p style="text-align: right; font-size: small;">A0013570</p>	<p style="text-align: right; font-size: small;">A0018161</p>
<i>Maximum number of terminals, without integrated overvoltage protection</i>	<i>Maximum number of terminals, with integrated overvoltage protection</i>
<p>1 Output 1 (passive): supply voltage and signal transmission</p> <p>2 Output 2 (passive): supply voltage and signal transmission</p> <p>3 Ground terminal for cable shield</p>	

Order code for "Output"	Terminal numbers			
	Output 1		Output 2	
	1 (+)	2 (-)	3 (+)	4 (-)
Option A	4-20 mA HART (passive)		-	
Option B <sup>1)</sup>	4-20 mA HART (passive)		Pulse/frequency/switch output (passive)	
Option C <sup>1)</sup>	4-20 mA HART (passive)		4-20 mA analog (passive)	
Option E <sup>1) 2)</sup>	FOUNDATION Fieldbus		Pulse/frequency/switch output (passive)	
Option G <sup>1) 3)</sup>	PROFIBUS PA		Pulse/frequency/switch output (passive)	

- 1) Output 1 must always be used; output 2 is optional.
- 2) FOUNDATION Fieldbus with integrated reverse polarity protection.
- 3) PROFIBUS PA with integrated reverse polarity protection.

**Pin assignment, device plug**

**PROFIBUS PA**

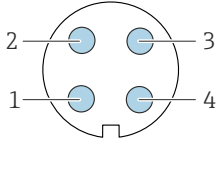
	Pin	Assignment	Coding	Plug/socket	
	1	+	PROFIBUS PA +	A	Plug
	2		Grounding		
	3	-	PROFIBUS PA -		
	4		Not assigned		

**FOUNDATION Fieldbus**

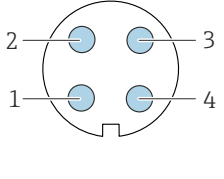
	Pin	Assignment	Coding	Plug/socket	
	1	+	Signal +	A	Plug
	2	-	Signal -		
	3		Grounding		
	4		Not assigned		

**Supply voltage**



**Transmitter**



An external power supply is required for each output.



Order code for "Output"	Minimum terminal voltage	Maximum terminal voltage
Option A <sup>1) 2)</sup> : 4-20 mA HART	<ul style="list-style-type: none"> <li>■ For 4 mA: ≥ DC 17.9 V</li> <li>■ For 20 mA: ≥ DC 13.5 V</li> </ul>	DC 35 V
Option B <sup>1) 2)</sup> : 4-20 mA HART, pulse/frequency/switch output	<ul style="list-style-type: none"> <li>■ For 4 mA: ≥ DC 17.9 V</li> <li>■ For 20 mA: ≥ DC 13.5 V</li> </ul>	DC 35 V
Option C <sup>1) 2)</sup> : 4-20 mA HART + 4-20 mA analog	<ul style="list-style-type: none"> <li>■ For 4 mA: ≥ DC 17.9 V</li> <li>■ For 20 mA: ≥ DC 13.5 V</li> </ul>	DC 30 V

Order code for "Output"	Minimum terminal voltage	Maximum terminal voltage
Option E <sup>3)</sup> : FOUNDATION Fieldbus, pulse/frequency/switch output	≥ DC 9 V	DC 32 V
Option G <sup>3)</sup> : PROFIBUS PA, pulse/frequency/switch output	≥ DC 9 V	DC 32 V

- 1) External supply voltage of the power supply unit with load.
- 2) For device versions with SD03 local display: The terminal voltage must be increased by DC 2 V if backlighting is used.
- 3) For device version with SD03 local display: The terminal voltage must be increased by DC 0.5 V if backlighting is used.

 For information about the load see →  13



 Various power supply units can be ordered from Endress+Hauser: →  78

 For information on the Ex connection values →  14

**Power consumption**

**Transmitter**

Order code for "Output; input"	Maximum power consumption
Option A: 4-20 mA HART	770 mW
Option B: 4-20 mA HART, pulse/frequency/switch output	<ul style="list-style-type: none"> <li>▪ Operation with output 1: 770 mW</li> <li>▪ Operation with output 1 and 2: 2 770 mW</li> </ul>
Option C: 4-20 mA HART + 4-20 mA analog	<ul style="list-style-type: none"> <li>▪ Operation with output 1: 660 mW</li> <li>▪ Operation with output 1 and 2: 1 320 mW</li> </ul>
Option E: FOUNDATION Fieldbus, pulse/frequency/switch output	<ul style="list-style-type: none"> <li>▪ Operation with output 1: 576 mW</li> <li>▪ Operation with output 1 and 2: 2 576 mW</li> </ul>
Option G: PROFIBUS PA, pulse/frequency/switch output	<ul style="list-style-type: none"> <li>▪ Operation with output 1: 512 mW</li> <li>▪ Operation with output 1 and 2: 2 512 mW</li> </ul>

 For information on the Ex connection values →  14

**Current consumption**

**Current output**

For every 4-20 mA or 4-20 mA HART current output: 3.6 to 22.5 mA

 If the option **Defined value** is selected in the **Failure mode** parameter : 3.59 to 22.5 mA

**FOUNDATION Fieldbus**

18 mA

**PROFIBUS PA**

16 mA

**Power supply failure**

- Totalizers stop at the last value measured.
- Depending on the device version, the configuration is retained in the device memory or in the pluggable data memory (HistoROM DAT).
- Error messages (incl. total operated hours) are stored.

Electrical connection

Connecting the transmitter

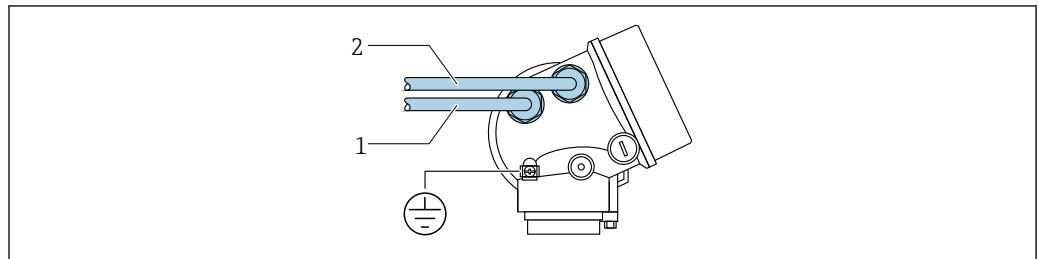

A0015510

- 1 Cable entry for output 1
- 2 Cable entry for output 2

Connection examples

Current output 4-20 mA HART

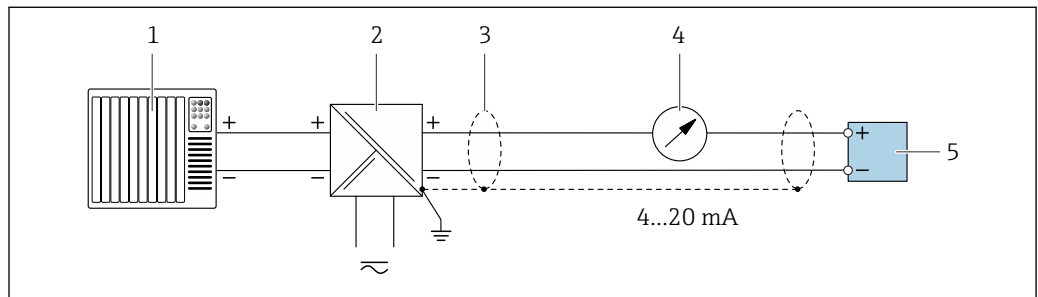

A0028762

1 Connection example for 4 to 20 mA HART current output (passive)

- 1 Automation system with current input (e.g. PLC)
- 2 Power supply
- 3 Cable shield provided at one end. The cable shield must be grounded at both ends to comply with EMC requirements; observe cable specifications
- 4 Analog display unit: observe maximum load
- 5 Transmitter

Pulse/frequency output

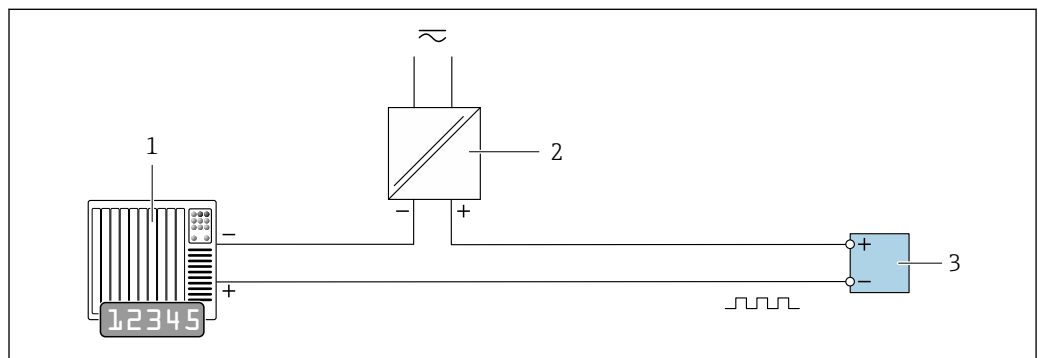

A0028761

2 Connection example for pulse/frequency output (passive)

- 1 Automation system with pulse/frequency input (e.g. PLC)
- 2 Power supply
- 3 Transmitter: Observe input values

Switch output

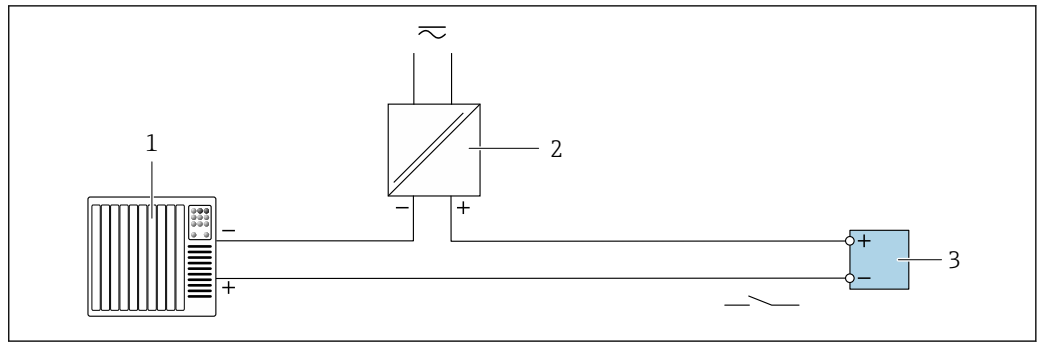

A0028760

3 Connection example for switch output (passive)

- 1 Automation system with switch input (e.g. PLC)
- 2 Power supply
- 3 Transmitter: Observe input values

FOUNDATION Fieldbus

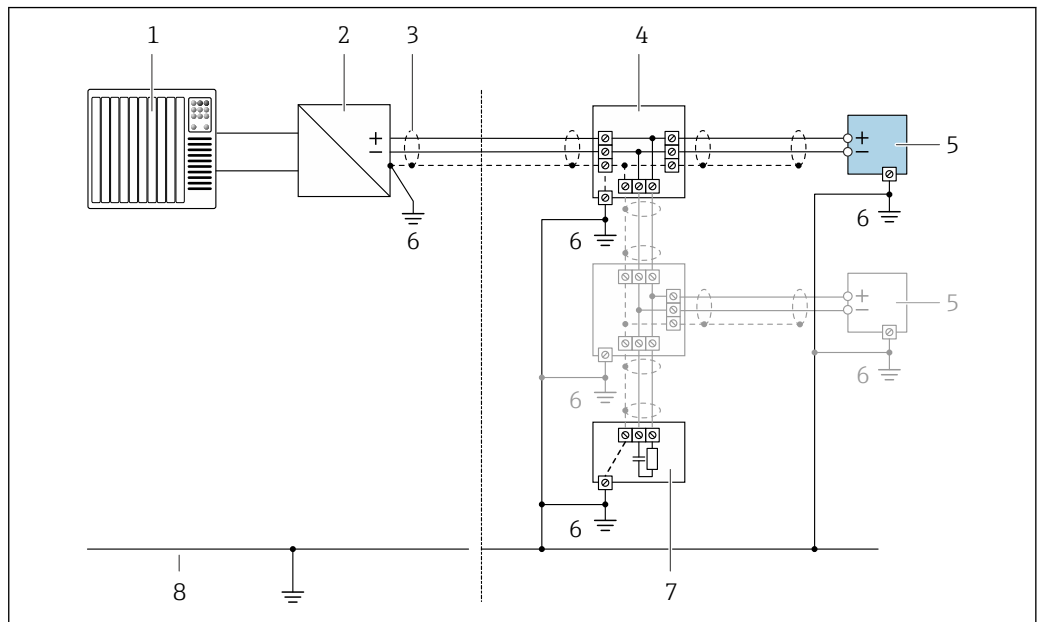

A0028768

4 Connection example for FOUNDATION Fieldbus

- 1 Control system (e.g. PLC)
- 2 Power Conditioner (FOUNDATION Fieldbus)
- 3 Cable shield provided at one end. The cable shield must be grounded at both ends to comply with EMC requirements; observe cable specifications
- 4 T-box
- 5 Measuring device
- 6 Local grounding
- 7 Bus terminator
- 8 Potential matching line

PROFIBUS PA

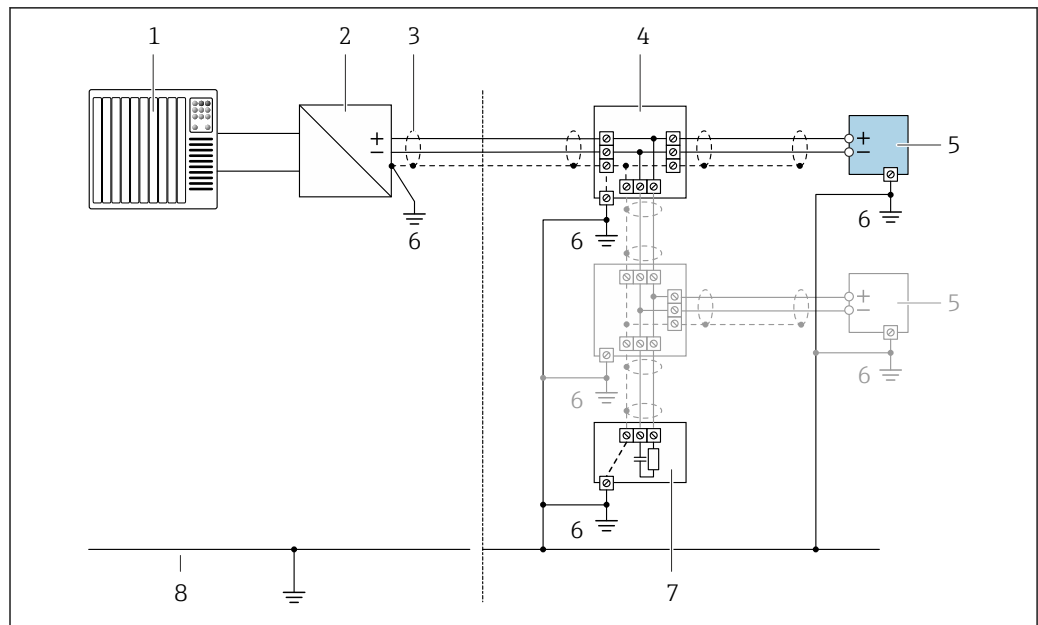

A0028768

5 Connection example for PROFIBUS PA

- 1 Control system (e.g. PLC)
- 2 PROFIBUS PA segment coupler
- 3 Cable shield provided at one end. The cable shield must be grounded at both ends to comply with EMC requirements; observe cable specifications
- 4 T-box
- 5 Measuring device
- 6 Local grounding
- 7 Bus terminator
- 8 Potential matching line

HART input

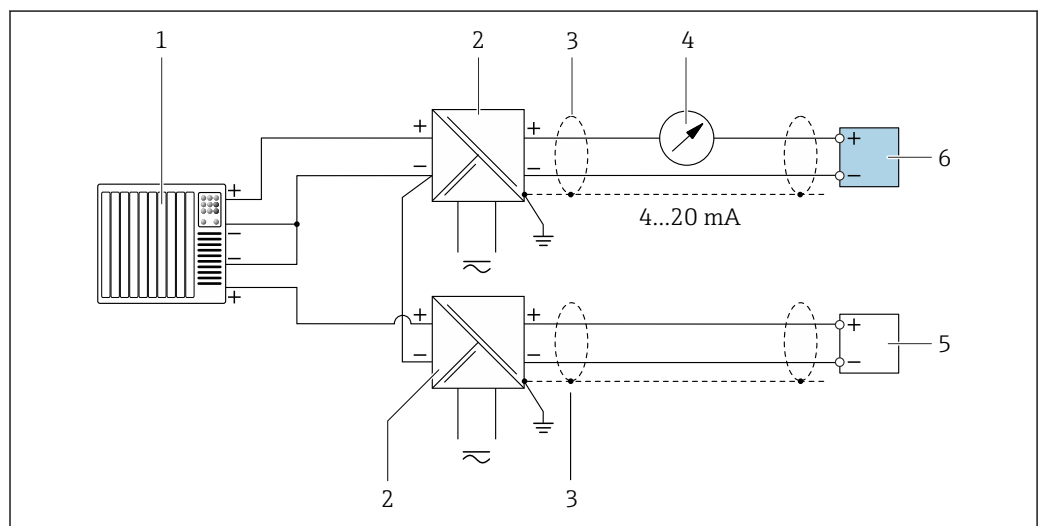

A0028763

6 Connection example for HART input with a common negative (passive)

- 1 Automation system with HART output (e.g. PLC)
- 2 Active barrier for power supply (e.g. RN22 1N)
- 3 Cable shield provided at one end. The cable shield must be grounded at both ends to comply with EMC requirements; observe cable specifications
- 4 Analog display unit: observe maximum load
- 5 Pressure measuring device (e.g. Cerabar M, Cerabar S): see requirements
- 6 Transmitter



Electrical connection

Connecting the transmitter

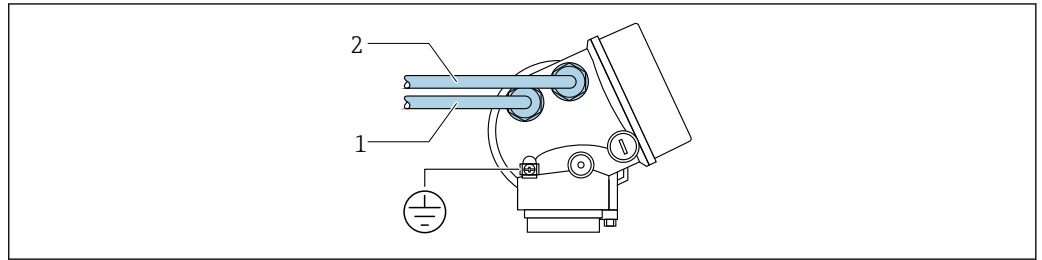

A0015510

- 1 Cable entry for output 1
- 2 Cable entry for output 2

Connection examples

Current output 4-20 mA HART

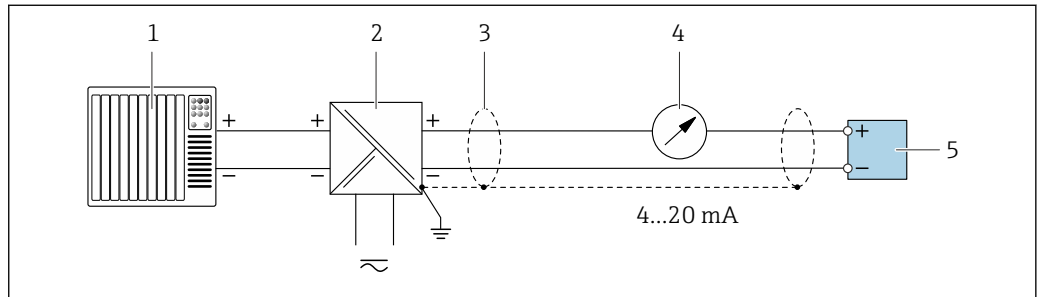

A0028762

7 Connection example for 4 to 20 mA HART current output (passive)

- 1 Automation system with current input (e.g. PLC)
- 2 Power supply
- 3 Cable shield provided at one end. The cable shield must be grounded at both ends to comply with EMC requirements; observe cable specifications
- 4 Analog display unit: observe maximum load
- 5 Transmitter

Pulse/frequency output

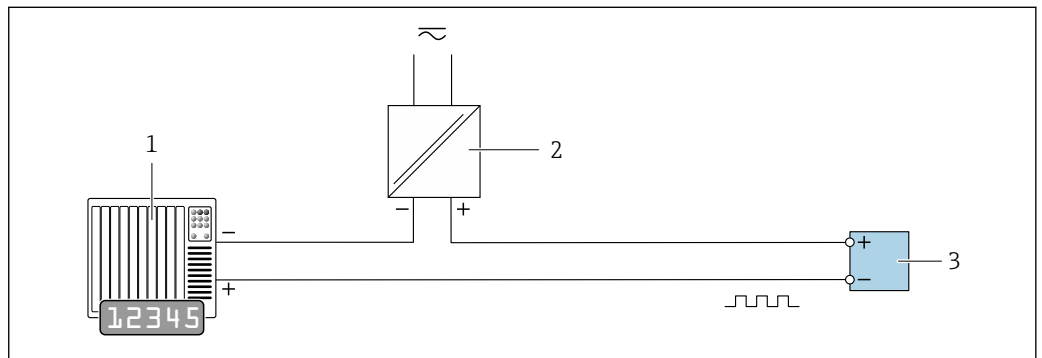

A0028761

8 Connection example for pulse/frequency output (passive)

- 1 Automation system with pulse/frequency input (e.g. PLC)
- 2 Power supply
- 3 Transmitter: Observe input values

Switch output

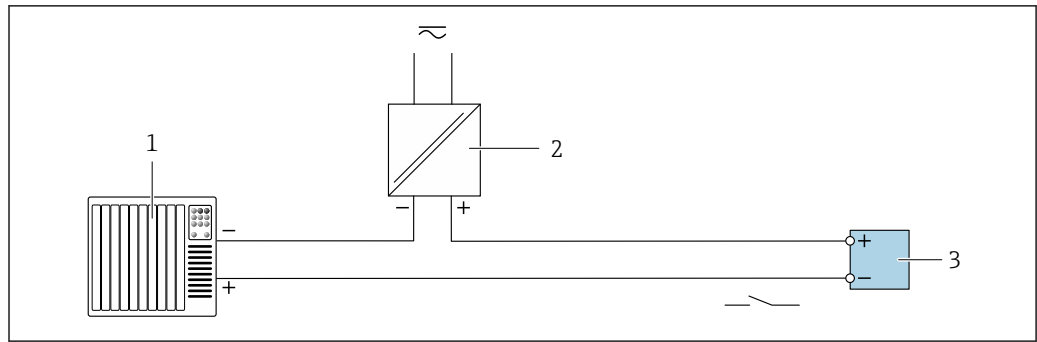

A0028760

9 Connection example for switch output (passive)

- 1 Automation system with switch input (e.g. PLC)
- 2 Power supply
- 3 Transmitter: Observe input values

FOUNDATION Fieldbus

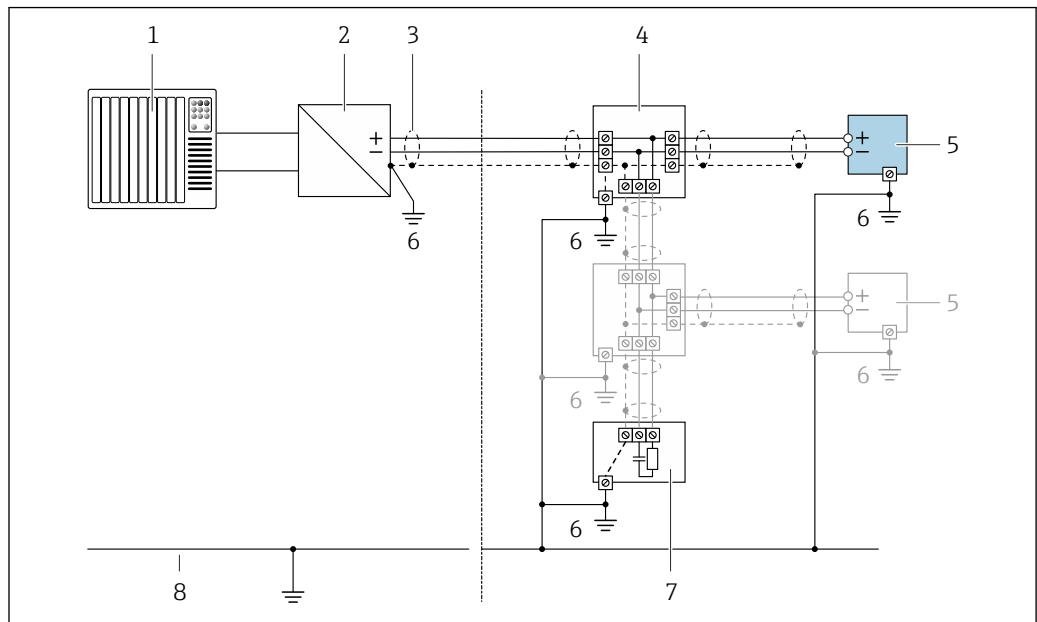

A0028768

10 Connection example for FOUNDATION Fieldbus

- 1 Control system (e.g. PLC)
- 2 Power Conditioner (FOUNDATION Fieldbus)
- 3 Cable shield provided at one end. The cable shield must be grounded at both ends to comply with EMC requirements; observe cable specifications
- 4 T-box
- 5 Measuring device
- 6 Local grounding
- 7 Bus terminator
- 8 Potential matching line

PROFIBUS PA

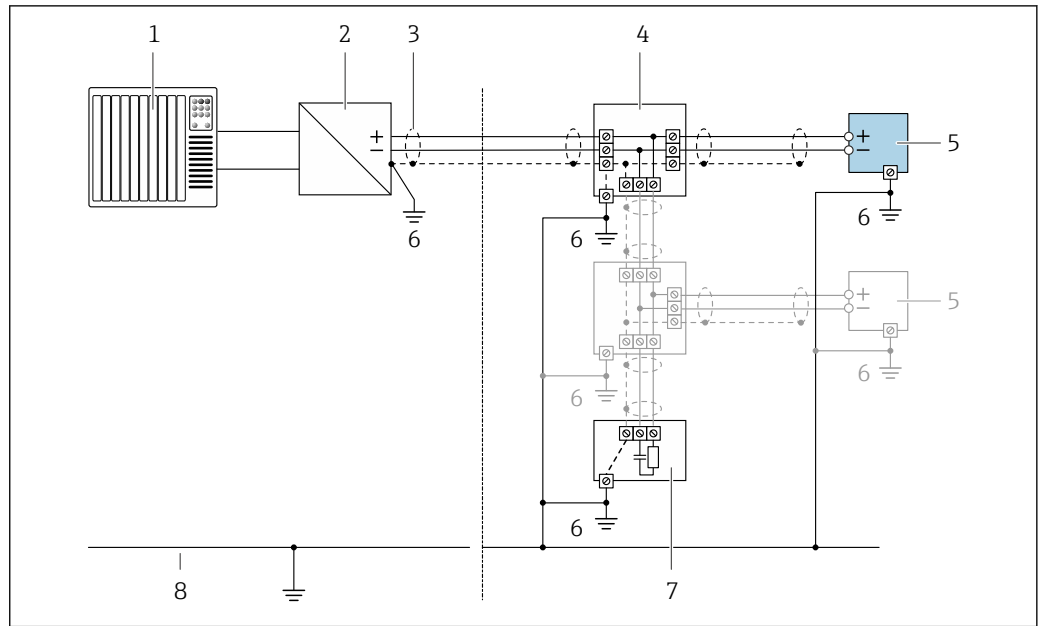

A0028768

11 Connection example for PROFIBUS PA

- 1 Control system (e.g. PLC)
- 2 PROFIBUS PA segment coupler
- 3 Cable shield provided at one end. The cable shield must be grounded at both ends to comply with EMC requirements; observe cable specifications
- 4 T-box
- 5 Measuring device
- 6 Local grounding
- 7 Bus terminator
- 8 Potential matching line

HART input

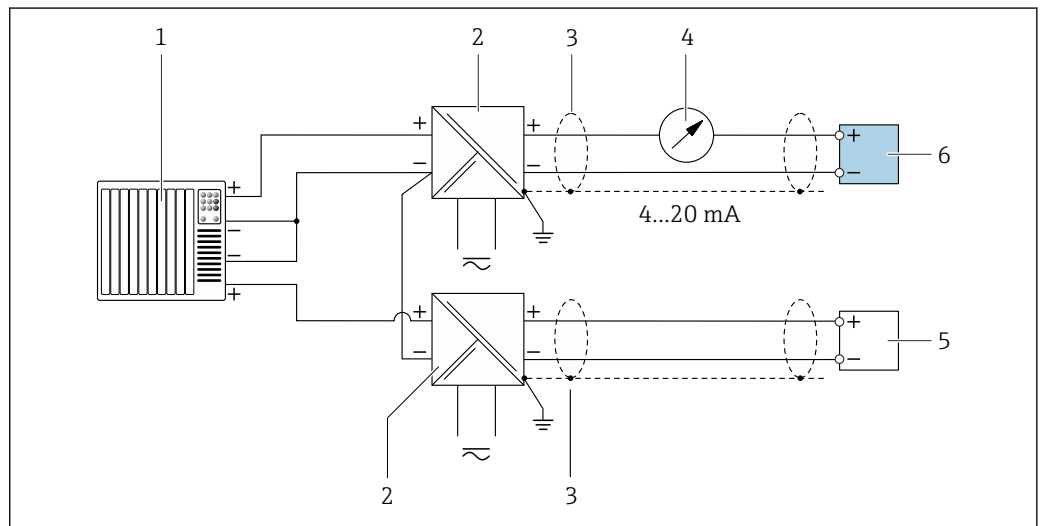

A0028763

12 Connection example for HART input with a common negative (passive)

- 1 Automation system with HART output (e.g. PLC)
- 2 Active barrier for power supply (e.g. RN221N)
- 3 Cable shield provided at one end. The cable shield must be grounded at both ends to comply with EMC requirements; observe cable specifications
- 4 Analog display unit: observe maximum load
- 5 Pressure measuring device (e.g. Cerabar M, Cerabar S): see requirements
- 6 Transmitter

**Potential equalization****Requirements**

No special measures for potential equalization are required.



For devices intended for use in hazardous locations, please observe the guidelines in the Ex documentation (XA).

**Terminals**

- For device version without integrated overvoltage protection: plug-in spring terminals for wire cross-sections 0.5 to 2.5 mm<sup>2</sup> (20 to 14 AWG)
- For device version with integrated overvoltage protection: screw terminals for wire cross-sections 0.2 to 2.5 mm<sup>2</sup> (24 to 14 AWG)

**Cable entries**

- Cable gland (not for Ex d): M20 × 1.5 with cable  $\varnothing$  6 to 12 mm (0.24 to 0.47 in)
- Thread for cable entry:
  - For non-hazardous and hazardous areas: NPT 1/2"
  - For non-hazardous and hazardous areas (not for XP): G 1/2"
  - For Ex d: M20 × 1.5

**Cable specification****Permitted temperature range**

- The installation guidelines that apply in the country of installation must be observed.
- The cables must be suitable for the minimum and maximum temperatures to be expected.

**Signal cable**

*Current output 4 to 20 mA HART*

A shielded cable is recommended. Observe grounding concept of the plant.

*Current output 4 to 20 mA*

Standard installation cable is sufficient.

*Pulse/frequency/switch output*

Standard installation cable is sufficient.

*FOUNDATION Fieldbus*

Twisted, shielded two-wire cable.



For further information on planning and installing FOUNDATION Fieldbus networks see:

- Operating Instructions for "FOUNDATION Fieldbus Overview" (BA00013S)
- FOUNDATION Fieldbus Guideline
- IEC 61158-2 (MBP)

*PROFIBUS PA*

Twisted, shielded two-wire cable. Cable type A is recommended .



For further information on planning and installing PROFIBUS networks see:

- Operating Instructions "PROFIBUS DP/PA: Guidelines for planning and commissioning" (BA00034S)
- PNO Directive 2.092 "PROFIBUS PA User and Installation Guideline"
- IEC 61158-2 (MBP)

**Overvoltage protection**

The device can be ordered with integrated overvoltage protection for diverse approvals:

*Order code for "Accessory mounted", option NA "Overvoltage protection"*

<b>Input voltage range</b>	Values correspond to supply voltage specifications →  20 <sup>1)</sup>
<b>Resistance per channel</b>	2 · 0.5 $\Omega$ max.
<b>DC sparkover voltage</b>	400 to 700 V
<b>Trip surge voltage</b>	< 800 V
<b>Capacitance at 1 MHz</b>	< 1.5 pF

<b>Nominal discharge current (8/20 µs)</b>	10 kA
<b>Temperature range</b>	-40 to +85 °C (-40 to +185 °F)

1) The voltage is reduced by the amount of the internal resistance  $I_{min} \cdot R_i$



 Depending on the temperature class, restrictions apply to the ambient temperature for device versions with overvoltage protection .

 For detailed information on the temperature tables, see the "Safety Instructions" (XA) for the device.

## Performance characteristics

### Reference operating conditions



- Error limits based on ISO 11631
- Water with +15 to +45 °C (+59 to +113 °F) at 2 to 6 bar (29 to 87 psi)
- Specifications as per calibration protocol
- Accuracy based on accredited calibration rigs that are traced to ISO 17025.

 To obtain measured errors, use the *Applicator* sizing tool →  78

### Maximum measured error

o.r. = of reading;  $1 \text{ g/cm}^3 = 1 \text{ kg/l}$ ; T = medium temperature

#### Base accuracy

 Design fundamentals →  32

#### Mass flow and volume flow (liquids)

±0.10 % o.r.

#### Mass flow (gases)

±0.35 % o.r.

#### Density (liquids)

Under reference conditions	Standard density calibration <sup>1)</sup>	Wide-range Density specification <sup>2) 3)</sup>
[g/cm <sup>3</sup> ]	[g/cm <sup>3</sup> ]	[g/cm <sup>3</sup> ]
±0.0005	±0.02	±0.002

1) Valid over the entire temperature and density range

2) Valid range for special density calibration: 0 to 2 g/cm<sup>3</sup>, +5 to +80 °C (+41 to +176 °F)

3) Order code for "Application package", option EE "Special density"

#### Temperature

±0.5 °C ± 0.005 · T °C (±0.9 °F ± 0.003 · (T - 32) °F)

**Zero point stability**

Standard version: order code for "Measuring tube mat., wetted surface", option BB, BF, HA, SA

DN		Zero point stability	
[mm]	[in]	[kg/h]	[lb/min]
1	1/24	0.0010	0.000036
2	1/12	0.0050	0.00018
4	1/8	0.0200	0.00072

High-pressure version: order code for "Measuring tube mat., wetted surface", option HB

DN		Zero point stability	
[mm]	[in]	[kg/h]	[lb/min]
1	1/24	0.0016	0.0000576
2	1/12	0.0080	0.000288
4	1/8	0.0320	0.001152

**Flow values**

Flow values as turndown parameter depending on nominal diameter.

SI units

DN [mm]	1:1	1:10	1:20	1:50	1:100	1:500
	[kg/h]	[kg/h]	[kg/h]	[kg/h]	[kg/h]	[kg/h]
1	20	2	1	0.4	0.2	0.04
2	100	10	5	2	1	0.2
4	450	45	22.5	9	4.5	0.9

US units

DN [inch]	1:1	1:10	1:20	1:50	1:100	1:500
	[lb/min]	[lb/min]	[lb/min]	[lb/min]	[lb/min]	[lb/min]
1/24	0.735	0.074	0.037	0.015	0.007	0.001
1/12	3.675	0.368	0.184	0.074	0.037	0.007
1/8	16.54	1.654	0.827	0.331	0.165	0.033

**Accuracy of outputs**

The outputs have the following base accuracy specifications.

Current output

Accuracy	±10 µA
----------	--------

Pulse/frequency output

o.r. = of reading

Accuracy	Max. ±100 ppm o.r.
----------	--------------------

**Repeatability**

o.r. = of reading; 1 g/cm<sup>3</sup> = 1 kg/l; T = medium temperature

**Base repeatability**

 Design fundamentals →  32

*Mass flow and volume flow (liquids)*

±0.05 % o.r.

*Mass flow (gases)*

±0.15 % o.r.

*Density (liquids)*

±0.00025 g/cm<sup>3</sup>

*Temperature*

±0.25 °C ± 0.0025 · T °C (±0.45 °F ± 0.0015 · (T-32) °F)

**Response time**

- The response time depends on the configuration (damping).
- Response time in the event of erratic changes in the measured variable: After 500 ms → 95 % of full scale value

**Influence of ambient temperature**

**Current output**

o.r. = of reading

Additional error, in relation to the span of 16 mA:

Temperature coefficient at zero point (4 mA)	0.02 %/10 K
Temperature coefficient with span (20 mA)	0.05 %/10 K

**Pulse/frequency output**

o.r. = of reading

Temperature coefficient	Max. ±100 ppm o.r.
-------------------------	--------------------

**Influence of medium temperature**

**Mass flow and volume flow**

o.f.s. = of full scale value

When there is a difference between the temperature for zero point adjustment and the process temperature, the additional measured error of the sensor is typically ±0.0002 % o.f.s./°C (±0.0001 % o. f.s./°F).

The effect is reduced if zero point adjustment is performed at process temperature.

**Density**

When there is a difference between the density calibration temperature and the process temperature, the typical measured error of the sensor is ±0.00005 g/cm<sup>3</sup> /°C (±0.000025 g/cm<sup>3</sup> /°F). Field density calibration is possible.

**Wide-range density specification (special density calibration)**

If the process temperature is outside the valid range (→  29) the measured error is ±0.00005 g/cm<sup>3</sup> /°C (±0.000025 g/cm<sup>3</sup> /°F)

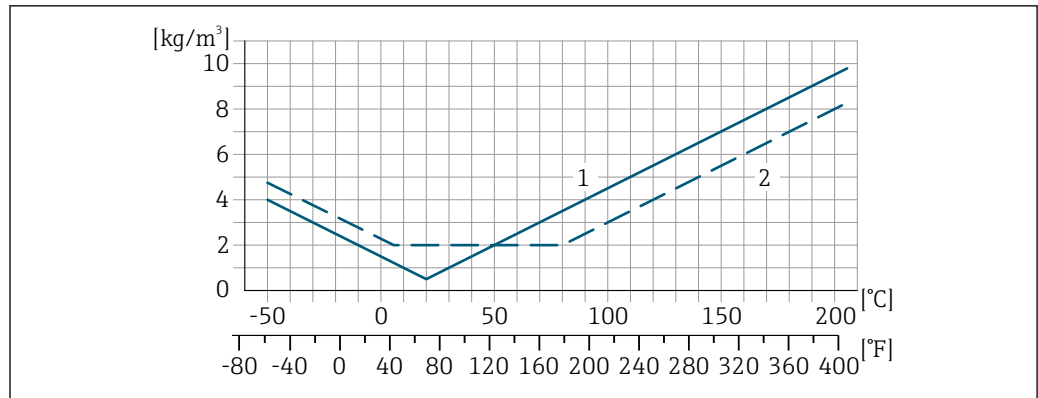

A0016616

- 1 Field density calibration, for example at +20 °C (+68 °F)
- 2 Special density calibration

**Influence of medium pressure**

A difference between the calibration pressure and process pressure does not affect accuracy.

**Design fundamentals**

o.r. = of reading, o.f.s. = of full scale value

BaseAccu = base accuracy in % o.r., BaseRepeat = base repeatability in % o.r.

MeasValue = measured value; ZeroPoint = zero point stability

*Calculation of the maximum measured error as a function of the flow rate*

Flow rate	Maximum measured error in % o.r.
$\geq \frac{\text{ZeroPoint}}{\text{BaseAccu}} \cdot 100$ <small>A0021332</small>	$\pm \text{BaseAccu}$ <small>A0021339</small>
$< \frac{\text{ZeroPoint}}{\text{BaseAccu}} \cdot 100$ <small>A0021333</small>	$\pm \frac{\text{ZeroPoint}}{\text{MeasValue}} \cdot 100$ <small>A0021334</small>

*Calculation of the maximum repeatability as a function of the flow rate*

Flow rate	Maximum repeatability in % o.r.
$\geq \frac{4/3 \cdot \text{ZeroPoint}}{\text{BaseAccu}} \cdot 100$ <small>A0021341</small>	$\pm 1/2 \cdot \text{BaseAccu}$ <small>A0021343</small>
$< \frac{4/3 \cdot \text{ZeroPoint}}{\text{BaseAccu}} \cdot 100$ <small>A0021342</small>	$\pm 2/3 \cdot \frac{\text{ZeroPoint}}{\text{MeasValue}} \cdot 100$ <small>A0021344</small>

**Example for maximum measured error**

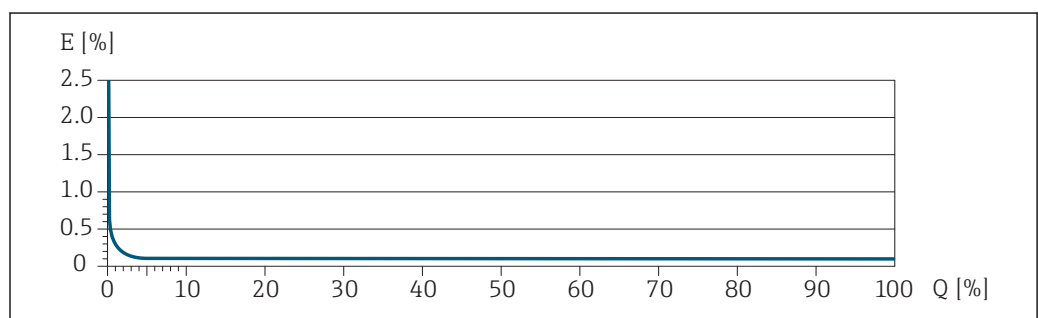



A0030378

- E Maximum measured error in % o.r. (example)
- Q Flow rate in % of maximum full scale value



## Installation

 Use a sensor holder for additional stability in the process pipe and for non-flanged process connections. →  35

### Mounting location

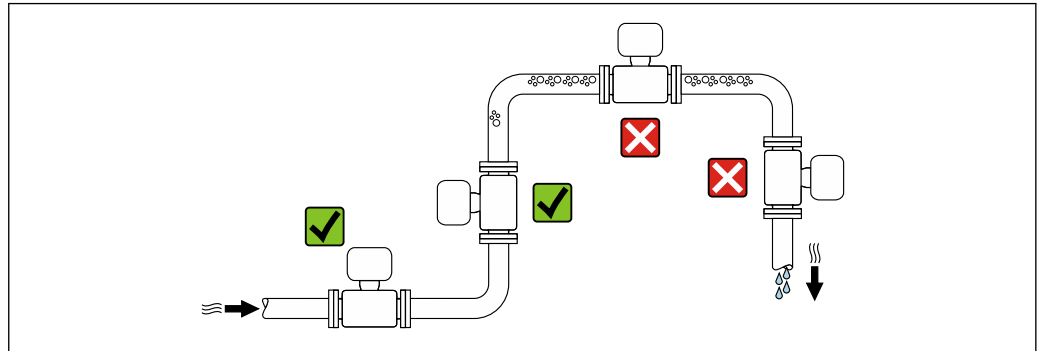

A0028772

To prevent measuring errors arising from accumulation of gas bubbles in the measuring tube, avoid the following mounting locations in the pipe:

- Highest point of a pipeline.
- Directly upstream of a free pipe outlet in a down pipe.

### Installation in down pipes

However, the following installation suggestion allows for installation in an open vertical pipeline. Pipe restrictions or the use of an orifice with a smaller cross-section than the nominal diameter prevent the sensor running empty while measurement is in progress.

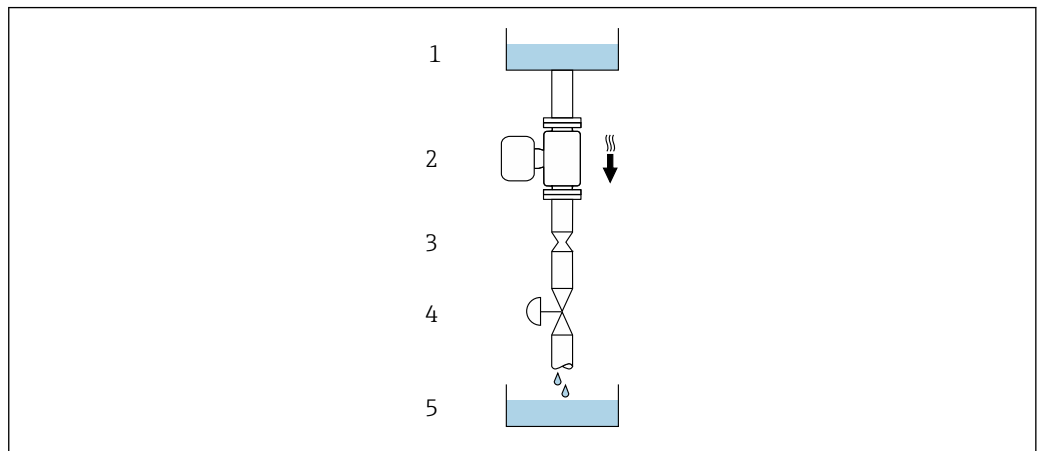

A0028773

 13 Installation in a down pipe (e.g. for batching applications)

- 1 Supply tank
- 2 Sensor
- 3 Orifice plate, pipe restriction
- 4 Valve
- 5 Batching tank

DN		Ø orifice plate, pipe restriction	
[mm]	[in]	[mm]	[in]
1	1/24	0.8	0.03
2	1/12	1.5	0.06
4	1/8	3.0	0.12

### Orientation

The direction of the arrow on the sensor nameplate helps you to install the sensor according to the flow direction (direction of medium flow through the piping).

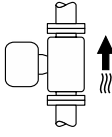
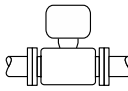
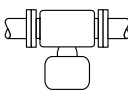
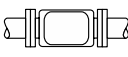
Orientation		Recommendation	
<b>A</b>	Vertical orientation	 A0015591	✓✓ <sup>1)</sup>
<b>B</b>	Horizontal orientation, transmitter at top	 A0015589	✓ <sup>2)</sup>
<b>C</b>	Horizontal orientation, transmitter at bottom	 A0015590	✓ <sup>3)</sup>
<b>D</b>	Horizontal orientation, transmitter at side	 A0015592	✓

- 1) This orientation is recommended to ensure self-draining.
- 2) Applications with low process temperatures may decrease the ambient temperature. To maintain the minimum ambient temperature for the transmitter, this orientation is recommended.
- 3) Applications with high process temperatures may increase the ambient temperature. To maintain the maximum ambient temperature for the transmitter, this orientation is recommended.

If a sensor is installed horizontally with a curved measuring tube, match the position of the sensor to the fluid properties.

#### Inlet and outlet runs



No special precautions need to be taken for fittings which create turbulence, such as valves, elbows or T-pieces, as long as no cavitation occurs →  43.

#### Special mounting instructions

##### Drainability

When the device is installed in a vertical position, the measuring tube can be drained completely and protected against deposit buildup if the properties of the measured liquid allow this. Furthermore, as only one measuring tube is used the flow is not impeded and the risk of product being retained in the measuring device is reduced to a minimum. The larger internal diameter of the measuring tube<sup>1)</sup> also reduces the risk of particles getting trapped in the measuring system. Due to the larger cross-section of the individual measuring tube, the tube is also generally less susceptible to clogging.

##### Sanitary compatibility

 When installing in hygienic applications, please refer to the information in the "Certificates and approvals/hygienic compatibility" section →  72

##### Rupture disk

Information that is relevant to the process: →  42.

##### WARNING

##### Danger from medium escaping!

Medium escaping under pressure can cause injury or material damage.

- ▶ Take precautions to prevent danger to persons and damage if the rupture disk is actuated.
- ▶ Observe information on the rupture disk sticker.
- ▶ Make sure that the function and operation of the rupture disk is not impeded through the installation of the device.
- ▶ Do not remove or damage the rupture disk, drain connection and warning signs.

The position of the rupture disk is indicated by an affixed sticker. In versions without a drain connection (order option CU), the sticker is destroyed if the rupture disk is triggered. The disk can therefore be visually monitored.

1) Compared with the double-tube design with a similar flow capacity and measuring tubes with a smaller internal diameter

To allow any escaping medium to drain in a controlled manner, a drain connection is available for the rupture disk integrated in the sensor: order code for "Sensor option", option CU "Drain connection for rupture disk". This connection is intended for a pipe connection with a 1/4" NPT thread and sealed with a grip plug for protection. To guarantee the function of the rupture disk with a drain connection, the drain connection must be connected to the drain system in a hermetically tight manner.

- i** The drain connection is firmly mounted in place by the manufacturer and may not be removed.
- i** It is not possible to use the holder with a measuring device with a drain connection for a rupture disk: order code for "Sensor option", option CU "Drain connection for rupture disk"
- i** It is not possible to use a heating jacket if the drain connection is used: order code for "Sensor option", option CU "Drain connection for rupture disk"

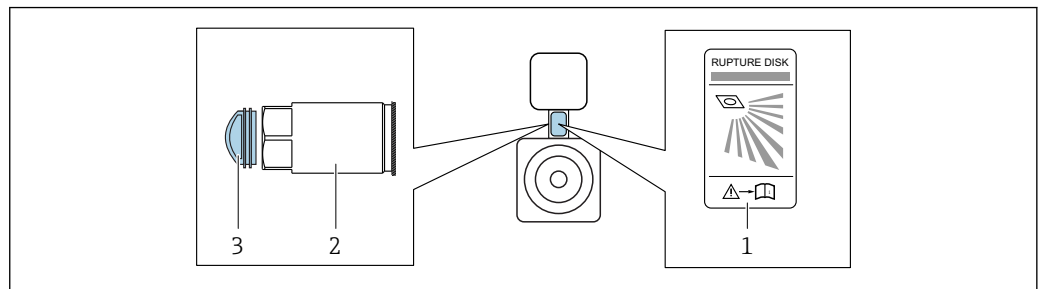

A0042344

- 1 Rupture disk label
- 2 Drain connection for rupture disk with 1/4" NPT female thread and 17mm width across flats (AF): order code for "Sensor option", option CU, drain connection for rupture disk
- 3 Transportation guard

For information on the dimensions: see the "Mechanical construction" section (accessories)  
 → 54

### Sensor holder

The sensor holder is used to secure the device to a wall, tabletop or pipe (order code for "Accessory enclosed", option PR).

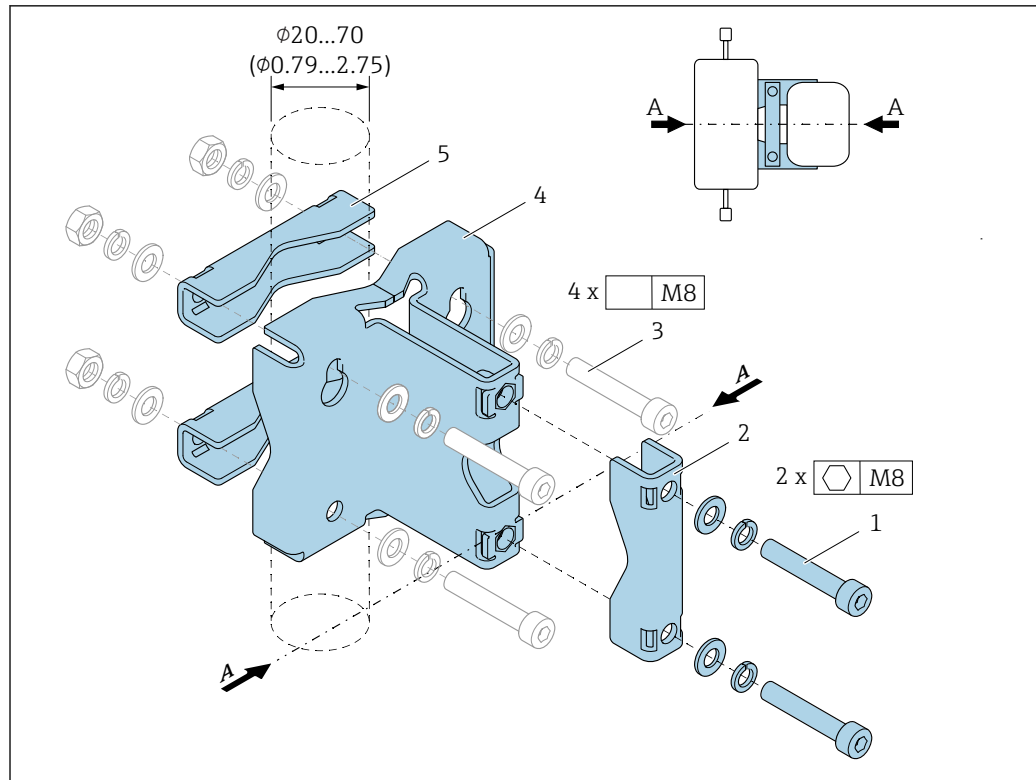

A0036471

- 1 2 x Allen screw M8 x 50, washer and spring washer A4  
 2 1 x clamp (measuring device neck)  
 3 4 x securing screw for wall, tabletop or pipe mounting (not supplied)  
 4 1 x base profile  
 5 2 x clamp (pipe mounting)  
 A Measuring device central line

If the holder is used with a measuring device fitted with a rupture disk, it is important to ensure that the rupture disk in the neck is not covered over and that the cover of the rupture disk is not damaged.

**i** Lubricate all threaded joints prior to mounting. The screws for wall, tabletop or pipe mounting are not supplied with the device and must be chosen to suit the individual installation position.

**⚠ WARNING**

**Strain on pipes!**

Excessive strain on an unsupported pipe can cause the pipe to break.

- Install the sensor in a pipe that is adequately supported.

The following mounting versions are recommended for the installation:

Use of the sensor holder.

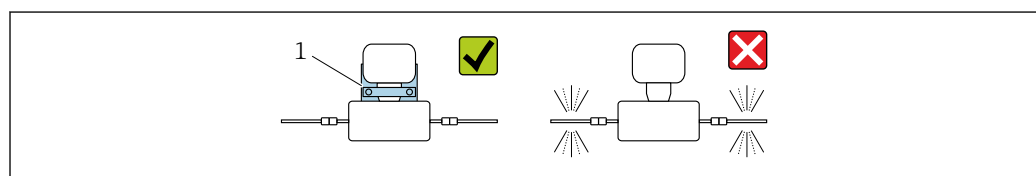

A0036492

- 1 Sensor holder (order code for "Accessory enclosed", option PR)

*Mounting on a wall*

Screw the sensor holder to the wall with four screws. Two of the four holes to secure the holder are designed to hook into the screws.

*Mounting on a table*

Screw the sensor holder onto the tabletop with four screws.

*Mounting on a pipe*

Secure the sensor holder to the pipe with two clamps.

**Zero point adjustment**

All measuring devices are calibrated in accordance with state-of-the-art technology. Calibration takes place under reference conditions →  29. Therefore, a zero point adjustment in the field is generally not required.

Experience shows that zero point adjustment is advisable only in special cases:



- To achieve maximum measuring accuracy even with low flow rates.
- Under extreme process or operating conditions (e.g. very high process temperatures or very high-viscosity fluids).

## Environment

**Ambient temperature range**

<b>Measuring device</b>	-40 to +60 °C (-40 to +140 °F)
<b>Readability of the local display</b>	-20 to +60 °C (-4 to +140 °F) The readability of the display may be impaired at temperatures outside the temperature range.

- ▶ If operating outdoors:  
Avoid direct sunlight, particularly in warm climatic regions.

 You can order a weather protection cover from Endress+Hauser. →  76.

**Storage temperature**

-40 to +80 °C (-40 to +176 °F), preferably at +20 °C (+68 °F)

**Climate class**

DIN EN 60068-2-38 (test Z/AD)

**Degree of protection**

**Transmitter**

- As standard: IP66/67, type 4X enclosure
- When housing is open: IP20, type 1 enclosure
- Display module: IP20, type 1 enclosure

**Sensor**  
IP66/67, type 4X enclosure

**Connector**  
IP67, only in screwed situation

**Vibration resistance**

- Oscillation, sinusoidal, following IEC 60068-2-6
  - 2 to 8.4 Hz, 3.5 mm peak
  - 8.4 to 2 000 Hz, 1 g peak
- Oscillation, broadband noise following IEC 60068-2-64
  - 10 to 200 Hz, 0.003 g<sup>2</sup>/Hz
  - 200 to 2 000 Hz, 0.001 g<sup>2</sup>/Hz
  - Total: 1.54 g rms

**Shock resistance**

Shock, half-sine according to IEC 60068-2-27  
6 ms 30 g

**Shock resistance**

Shock due to rough handling following IEC 60068-2-31

**Interior cleaning**

- Cleaning in place (CIP)
- Sterilization in place (SIP)

**Options**

Oil- and grease-free version for wetted parts, without declaration  
 Order code for "Service", option HA

**Electromagnetic compatibility (EMC)**

As per IEC/EN 61326 and NAMUR Recommendation 21 (NE 21)



Details are provided in the Declaration of Conformity.

**Process**

**Medium temperature range** -50 to +205 °C (-58 to +401 °F)

**Density** 0 to 2 000 kg/m<sup>3</sup> (0 to 125 lb/cf)

**Pressure-temperature ratings**

The following pressure/temperature diagrams apply to all pressure-bearing parts of the device and not just the process connection. The diagrams show the maximum permissible medium pressure depending on the specific medium temperature.

**Flange connection according to EN 1092-1 (DIN 2501)**

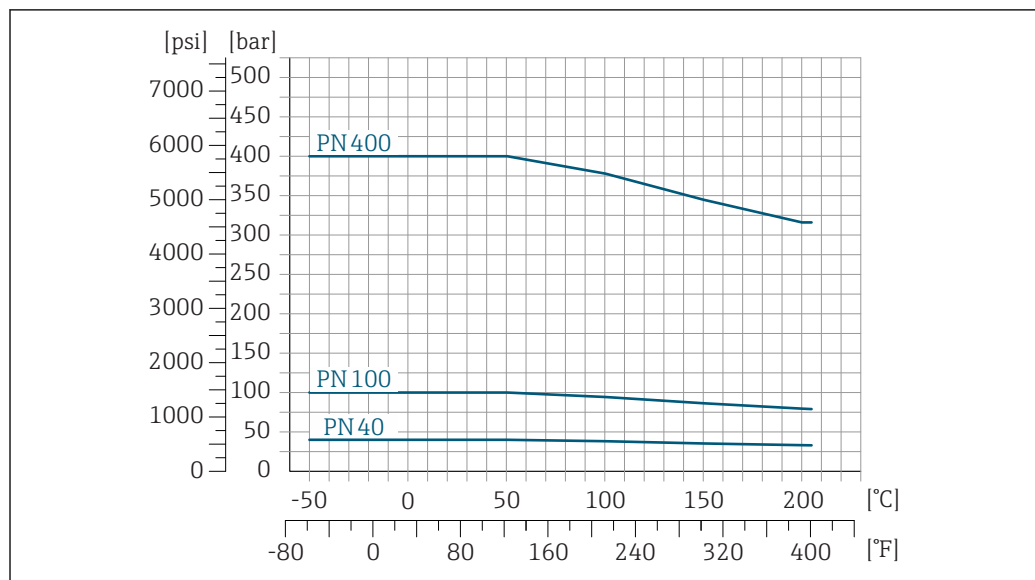

A0036181-EN

14 With flange material: 1.4404 (316/316L)

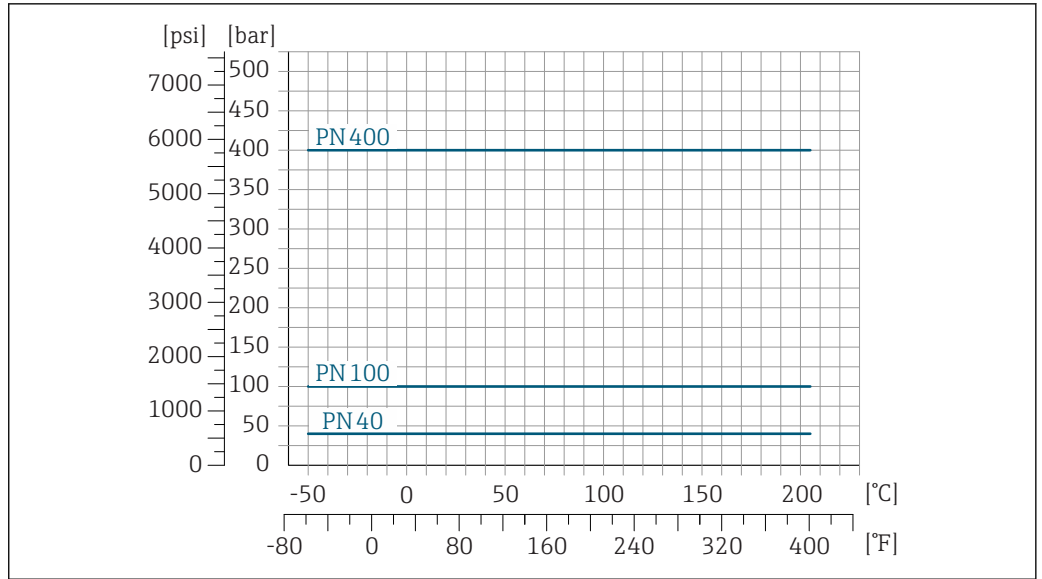

A0036194-EN

15 With flange material: Alloy C22, 2.4602 (UNS N06022)

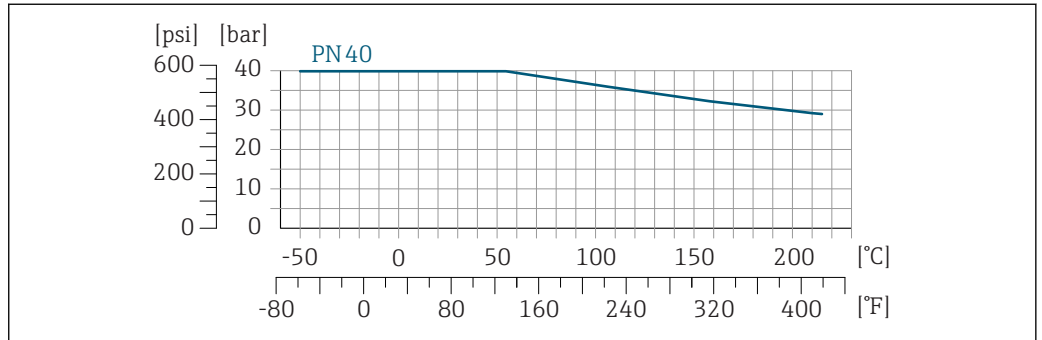

A0036200-EN

16 Lap joint flange with flange material: 1.4301 (F304), wetted parts Alloy C22: 2.4602 (UNS N06022)

**Flange connection according to ASME B16.5**

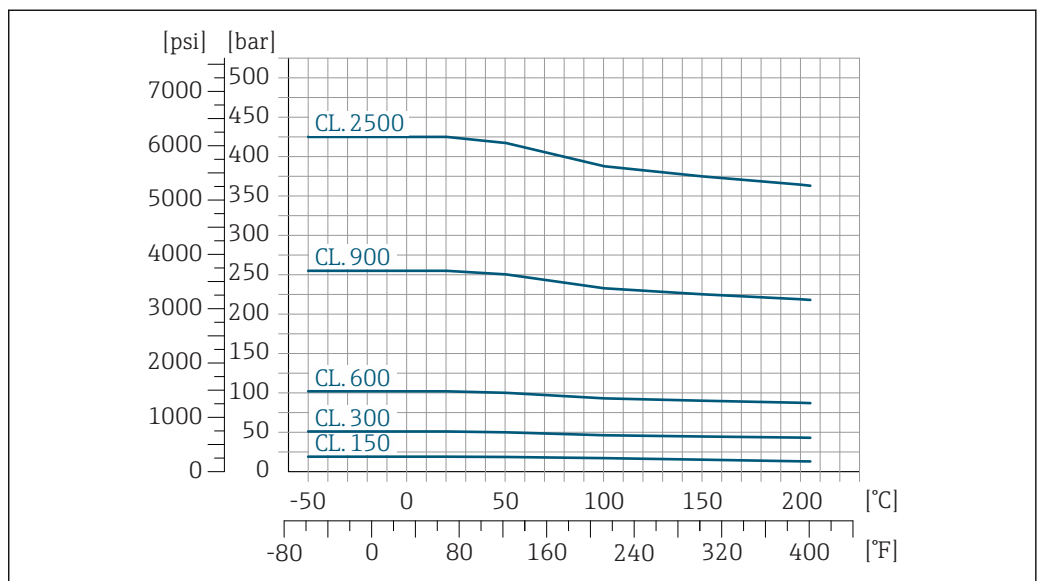

A0036201-EN

17 With flange material: 1.4404 (316/316L)

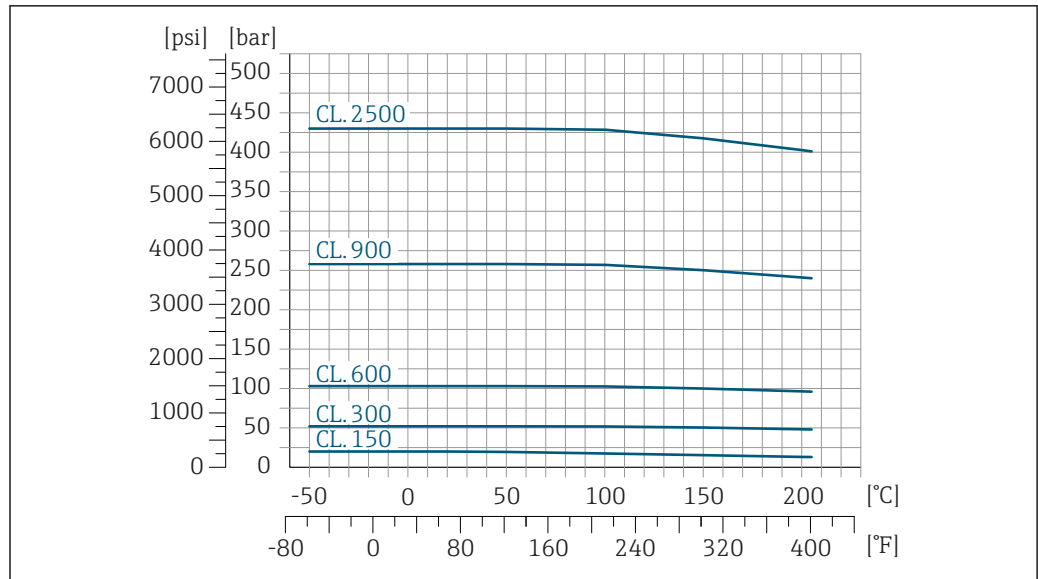

A0036203-EN

18 With flange material: Alloy C22, 2.4602 (UNS N06022)

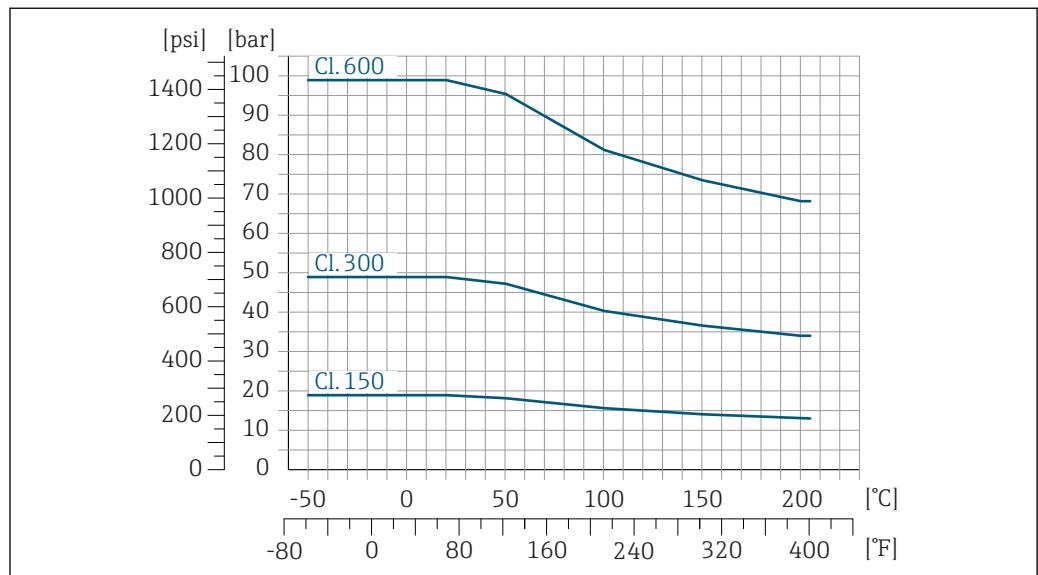

A0036202-EN

19 Lap joint flange with flange material: 1.4301 (F304), wetted parts Alloy C22: 2.4602 (UNS N06022)

**Flange connection according to JIS B2220**

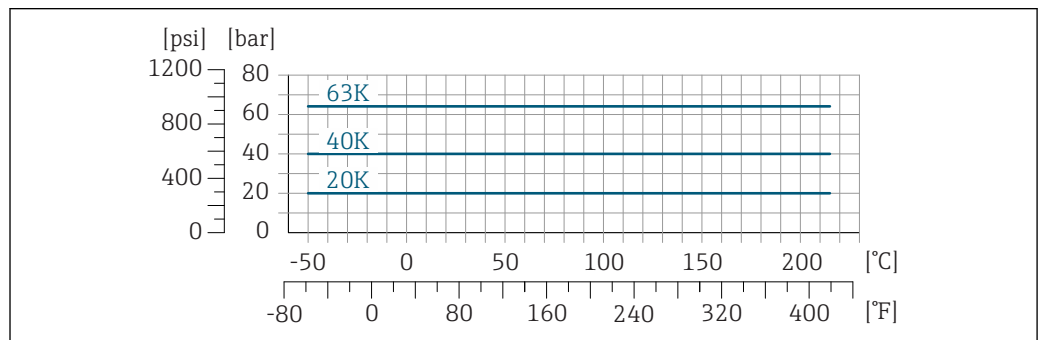

A0036204-EN

20 With flange material: 1.4404 (316/316L) or Alloy C22, 2.4602 (UNS N06022)



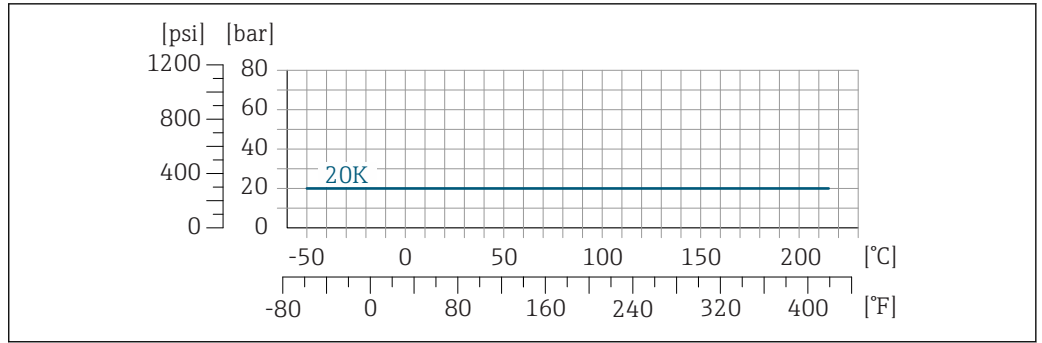

21 Lap joint flange with flange material: 1.4301 (F304), wetted parts Alloy C22: 2.4602 (UNS N06022)

**Tri-Clamp process connection**

The clamp connections are suitable up to a maximum pressure of 40 bar (580 psi). Please observe the operating limits of the clamp and seal used as they could be under 40 bar (580 psi). The clamp and seal are not included in the scope of supply.

**Process connection 4-VCO-4, NPT 1/4", NTP 1/2", G 1/4", G 1/2"**

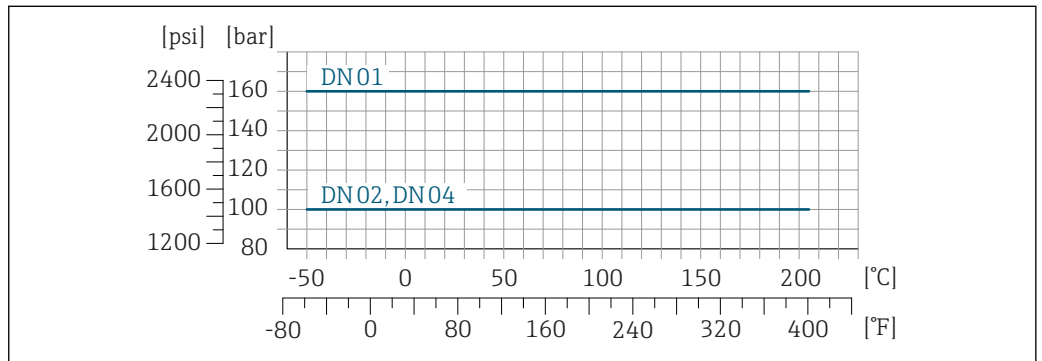

22 With flange material: 1.4404 (316/316L)

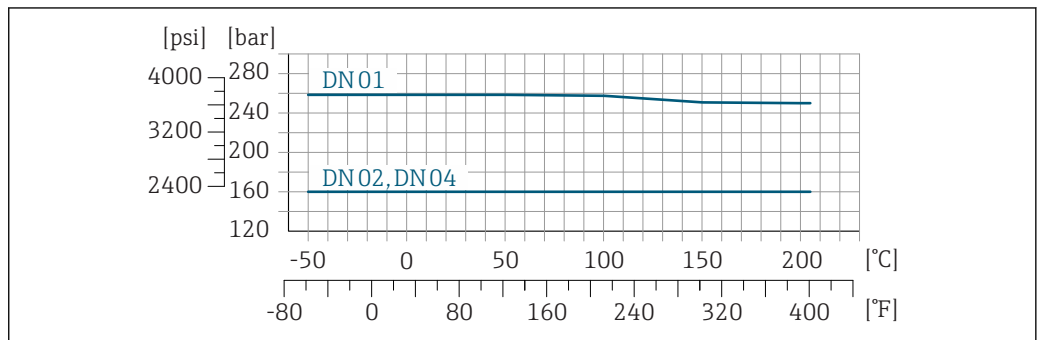

23 With flange material: Alloy C22, 2.4602 (UNS N06022)

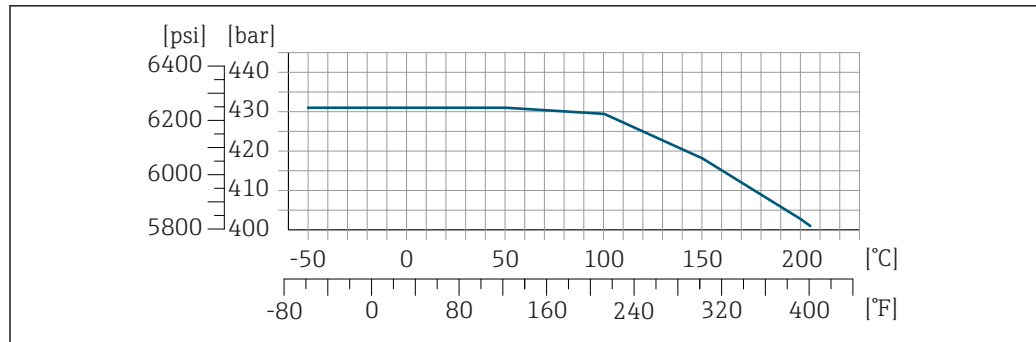

A0036211-EN

24 With flange material: Alloy C22, 2.4602 (UNS N06022)

## Sensor housing

The sensor housing is filled with dry nitrogen gas and protects the electronics and mechanics inside.

**i** If a measuring tube fails (e.g. due to process characteristics like corrosive or abrasive fluids), the fluid will initially be contained by the sensor housing.

In the event of a tube failure, the pressure level inside the sensor housing will rise according to the operating process pressure. If the user judges that the sensor housing burst pressure does not provide an adequate safety margin, the device can be fitted with a rupture disk. This prevents excessively high pressure from forming inside the sensor housing. Therefore, the use of a rupture disk is strongly recommended in applications involving high gas pressures, and particularly in applications in which the process pressure is greater than 2/3 of the sensor housing burst pressure.

**i** High-pressure devices are always fitted with a rupture disk: order code for "Measuring tube mat., wetted surface", option HB

### Burst pressure of the sensor housing

If the device is fitted with a rupture disk (order code for "Sensor option", option CA "Rupture disk"), the rupture disk trigger pressure is decisive.

The sensor housing burst pressure refers to a typical internal pressure which is reached prior to mechanical failure of the sensor housing and which was determined during type testing. The corresponding type test declaration can be ordered with the device (order code for "Additional approval", option LN "Sensor housing burst pressure, type test").

DN		Sensor housing burst pressure	
[mm]	[in]	[bar]	[psi]
1	1/24	220	3 190
2	1/12	140	2 030
4	1/8	105	1 520

## Rupture disk

To increase the level of safety, a device version with a rupture disk with a trigger pressure of 10 to 15 bar (145 to 217.5 psi) can be used (order code for "Sensor option", option CA "rupture disk").

### Drain connection for rupture disk

To allow any escaping medium to drain in a controlled manner in the event of an error, an optional drain connection can be ordered in addition to the rupture disk.

**i** The function of the rupture disk is not compromised in any way.

## Flow limit

Select the nominal diameter by optimizing between the required flow range and permissible pressure loss.

**i** For an overview of the full scale values for the measuring range, see the "Measuring range" section → 9

- The minimum recommended full scale value is approx. 1/20 of the maximum full scale value
- In most applications, 20 to 50 % of the maximum full scale value can be considered ideal
- A low full scale value must be selected for abrasive media (such as liquids with entrained solids): flow velocity < 1 m/s (< 3 ft/s).
- For gas measurement the following rules apply:
  - The flow velocity in the measuring tubes should not exceed half the sound velocity (0.5 Mach).
  - The maximum mass flow depends on the density of the gas: formula → 9

 To calculate the flow limit, use the *Applicator* sizing tool → 78

**Pressure loss**

 To calculate the pressure loss, use the *Applicator* sizing tool → 78

**System pressure**

It is important that cavitation does not occur, or that gases entrained in the liquids do not outgas. This is prevented by means of a sufficiently high system pressure.

For this reason, the following mounting locations are recommended:

- At the lowest point in a vertical pipe
- Downstream from pumps (no danger of vacuum)

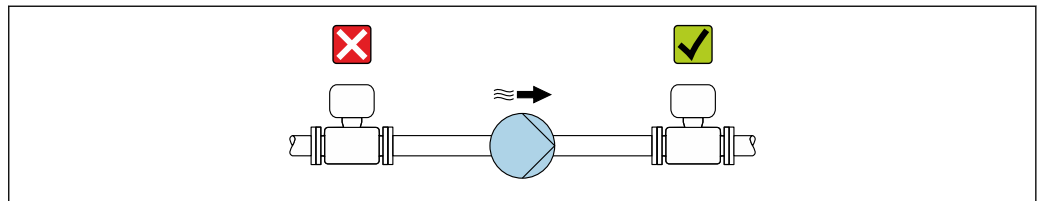

A0028777

**Thermal insulation**

In the case of some fluids, it is important to keep the heat radiated from the sensor to the transmitter to a low level. A wide range of materials can be used for the required insulation.

**NOTICE**

**Electronics overheating on account of thermal insulation!**

- ▶ Recommended orientation: horizontal orientation, transmitter housing pointing downwards.
- ▶ Do not insulate the transmitter housing .
- ▶ Maximum permissible temperature at the lower end of the transmitter housing: 80 °C (176 °F)
- ▶ Thermal insulation with extended neck free: We recommend that you do not insulate the extended neck in order to ensure optimum dissipation of heat.

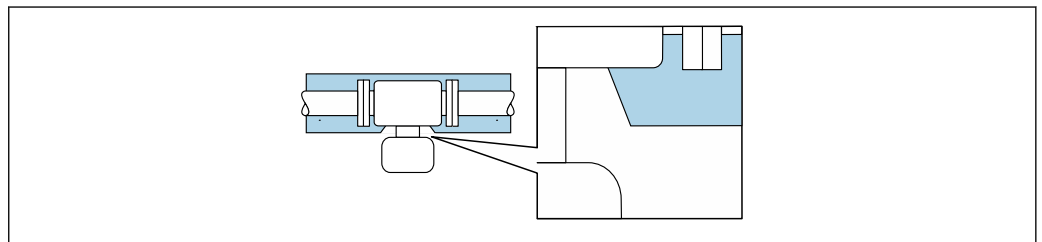

A0034391

 25 Thermal insulation with extended neck free

**Heating**

Some fluids require suitable measures to avoid loss of heat at the sensor.

**Heating options**

- Electrical heating, e.g. with electric band heaters
- Via pipes carrying hot water or steam
- Via heating jackets

 Heating jackets for the sensors can be ordered as accessories from Endress+Hauser. → 77

**NOTICE****Danger of overheating when heating**

- ▶ Ensure that the temperature at the lower end of the transmitter housing does not exceed 80 °C (176 °F).
- ▶ Ensure that sufficient convection takes place at the transmitter neck.
- ▶ Ensure that a sufficiently large area of the transmitter neck remains exposed. The uncovered part serves as a radiator and protects the electronics from overheating and excessive cooling.
- ▶ When using in potentially explosive atmospheres, observe the information in the device-specific Ex documentation. For detailed information on the temperature tables, see the separate document entitled "Safety Instructions" (XA) for the device.

---

**Vibrations**

The high oscillation frequency of the measuring tubes ensures that the correct operation of the measuring system is not influenced by plant vibrations.

## Mechanical construction

Dimensions in SI units

Compact version

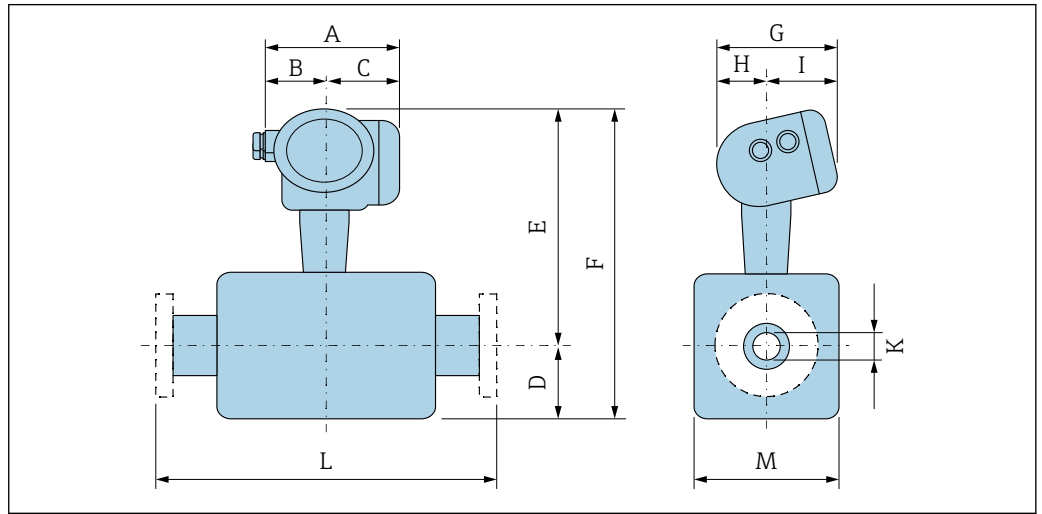

A0033792

Dimensions for version without overvoltage protection

Order code for "Housing", options B "GT18 dual compartment, 316L", C "GT20 dual compartment aluminum coated"

DN [mm]	A <sup>1)</sup> [mm]	B [mm]	C <sup>1)</sup> [mm]	D [mm]	E <sup>2)</sup> [mm]	F <sup>2)</sup> [mm]	G <sup>3)</sup> [mm]	H <sup>3)</sup> [mm]	I [mm]	K [mm]	L [mm]	M [mm]
1	165	75	90	54	279	333	162	102	60	1.1	<sup>4)</sup>	34
2	165	75	90	74	301	375	162	102	60	2.5	<sup>4)</sup>	48
4	165	75	90	90	316	406	162	102	60	3.9	<sup>4)</sup>	51

- 1) For versions with overvoltage protection (OVP): values + 8 mm
- 2) For version without local display: values - 3 mm
- 3) For version without local display: values - 7 mm
- 4) Dependent on respective process connection

**Threaded glands**

*VCO coupling*

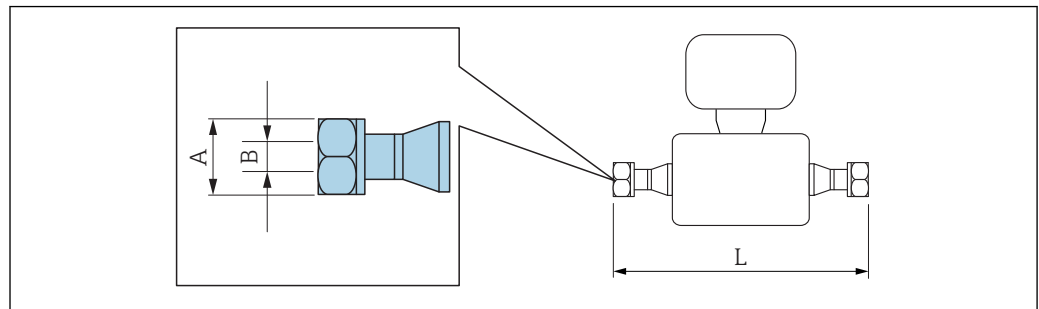

A0015624

**i** Length tolerance for dimension L in mm:  
+1.5 / -2.0

**4-VCO-4**

Order code for "Process connection", option HAW

1.4435 (316/316L): order code for "Measuring tube mat., wetted surface", option BB, BF, SA

Alloy C22: order code for "Measuring tube mat., wetted surface", option HA, HC, HD

Alloy C22, high pressure: order code for "Measuring tube mat., wetted surface", option HB

DN [mm]	A [in]	B [mm]		L [mm]
		Option BB, BF, SA, HA, HC, HD	Option HB	
1	AF 1 <sup>1</sup> / <sub>16</sub>	1.1	1	186
2	AF 1 <sup>1</sup> / <sub>16</sub>	2.5	2.1	263
4	AF 1 <sup>1</sup> / <sub>16</sub>	3.9	3.2	309

*G and NPT thread*

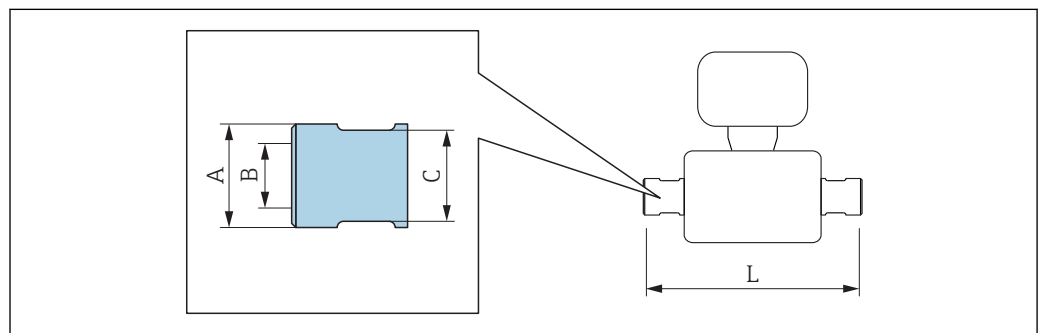

A0036429

**G 1/4"**

Order code for "Process connection", option G06

1.4404 (316L): order code for "Measuring tube mat., wetted surface", option SA

Alloy C22: order code for "Measuring tube mat., wetted surface", option HA

Alloy C22, high pressure: order code for "Measuring tube mat., wetted surface", option HB

DN [mm]	A [mm]		B [in]	C [mm]	L [mm]
	Option HA, SA	Option HB			
1	22.5	25	G 1/4"	AF 21	257
2	22.5	25	G 1/4"	AF 21	334
4	22.5	25	G 1/4"	AF 21	380

**G ½ "**  
 Order code for "Process connection", option G15  
 1.4404 (316L): order code for "Measuring tube mat., wetted surface", option SA  
 Alloy C22: order code for "Measuring tube mat., wetted surface", option HA  
 Alloy C22, high pressure: order code for "Measuring tube mat., wetted surface", option HB

DN [mm]	A [mm]		B [in]	C [mm]		L [mm]	
	Option HA, SA	Option HB		Option HA, SA	Option HB	Option HA, SA	Option HB
1	22.5	25	G ½ "	AF 27	AF 30	281	280
2	22.5	25	G ½ "	AF 27	AF 30	358	357
4	22.5	25	G ½ "	AF 27	AF 30	404	403

**NPT ¼ "**  
 Order code for "Process connection", option P06  
 1.4404 (316L): order code for "Measuring tube mat., wetted surface", option SA  
 Alloy C22: order code for "Measuring tube mat., wetted surface", option HA  
 Alloy C22, high pressure: order code for "Measuring tube mat., wetted surface", option HB

DN [mm]	A [mm]		B [in]	C [mm]	L [mm]
	Option HA, SA	Option HB			
1	22.5	25	NPT ¼ "	AF 19	257
2	22.5	25	NPT ¼ "	AF 19	334
4	22.5	25	NPT ¼ "	AF 19	380

**NPT ½ "**  
 Order code for "Process connection", option P15  
 1.4404 (316L): order code for "Measuring tube mat., wetted surface", option SA  
 Alloy C22: order code for "Measuring tube mat., wetted surface", option HA  
 Alloy C22, high pressure: order code for "Measuring tube mat., wetted surface", option HB

DN [mm]	A [mm]		B [in]	C [mm]		L [mm]	
	Option HA, SA	Option HB		Option HA, SA	Option HB	Option HA, SA	Option HB
1	22.5	25	NPT ½ "	AF 27	AF 30	281	280
2	22.5	25	NPT ½ "	AF 27	AF 30	358	357
4	22.5	25	NPT ½ "	AF 27	AF 30	404	403

## Clamp connections

### Tri-Clamp

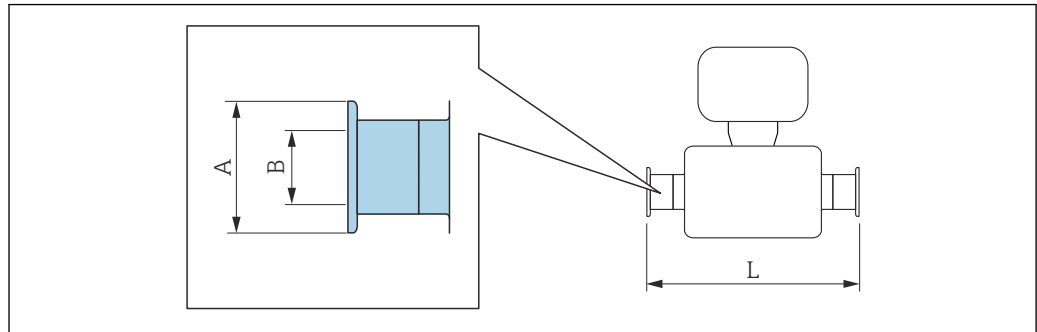

A0015625

**i** Length tolerance for dimension L in mm:  
+1.5 / -2.0

#### ½" Tri-Clamp

Order code for "Process connection", option FBW

1.4435 (316L): order code for "Measuring tube mat., wetted surface", option BB, BF, SA

Alloy C22: order code for "Measuring tube mat., wetted surface", option HA, HC, HD

DN [mm]	A [mm]	B [mm]	L [mm]
1	25	9.4	192
2	25	9.4	269
4	25	9.4	315

3-A version available ( $R_a \leq 0.76 \mu\text{m}/30 \mu\text{in}$ ,  $R_a \leq 0.38 \mu\text{m}/15 \mu\text{in}$ ):

Order code for "Measuring tube mat., wetted surface", option BB, BF, HC, HD in conjunction with order code for "Additional approval", option LP



**Flange connections**

*Fixed flange EN 1092-1, ASME B16.5, JIS B2220*

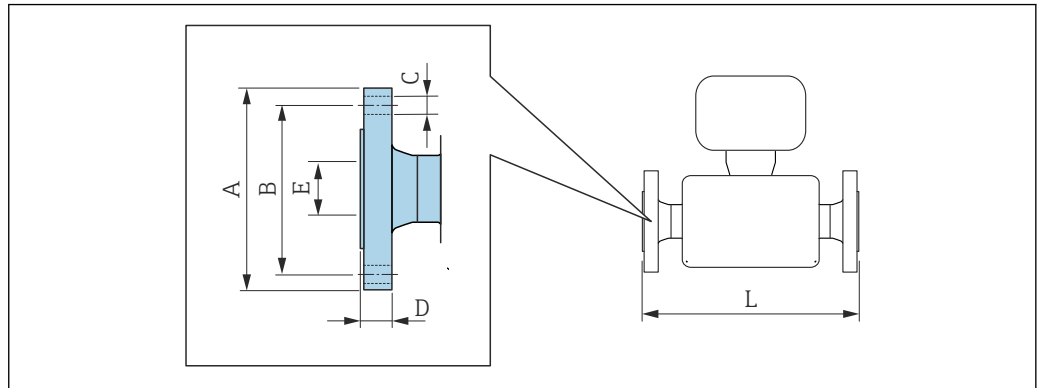

A0015621

**i** Length tolerance for dimension L in mm:  
+1.5 / -2.0

**Flange according to EN 1092-1 (DIN 2501 / DIN 2512N), PN 40**  
 1.4404 (F316/F316L): order code for "Process connection", option D2S  
 Alloy C22: order code for "Process connection", option D2C

**Flange with groove according to EN 1092-1 Form D (DIN 2512N), PN 40**  
 1.4404 (F316/F316L): order code for "Process connection", option D6S  
 Alloy C22: order code for "Process connection", option D6C

DN [mm]	A [mm]	B [mm]	C [mm]	D [mm]	E [mm]	L [mm]
1	95	65	4 × Ø14	16	17.3	262
2	95	65	4 × Ø14	16	17.3	339
4	95	65	4 × Ø14	16	17.3	385

Surface roughness (flange): EN 1092-1 Form B1 (DIN 2526 Form C), Ra 3.2 to 12.5 µm

**Flange according to EN 1092-1 (DIN 2501 / DIN 2512N), PN 100**  
 1.4404 (F316/F316L): order code for "Process connection", option D4S  
 Alloy C22: order code for "Process connection", option D4C

**Flange with groove according to EN 1092-1 Form D (DIN 2512N), PN 100**  
 1.4404 (F316/F316L): order code for "Process connection", option D8S  
 Alloy C22: order code for "Process connection", option D8C

DN [mm]	A [mm]	B [mm]	C [mm]	D [mm]	E [mm]	L [mm]
1	105	75	4 × Ø14	20	17.3	292
2	105	75	4 × Ø14	20	17.3	369
4	105	75	4 × Ø14	20	17.3	415

Surface roughness (flange): EN 1092-1 Form B1 (DIN 2526 Form C), Ra 3.2 to 12.5 µm

<b>Flange according to EN 1092-1 (DIN 2501 / DIN 2512N), PN 400</b> <b>1.4404 (F316/F316L): order code for "Process connection", option DNS</b> <b>Alloy C22: order code for "Process connection", option DNC</b>						
<b>Flange with groove according to EN 1092-1 Form D (DIN 2512N), PN 400</b> <b>1.4404 (F316/F316L): order code for "Process connection", option DPS</b> <b>Alloy C22: order code for "Process connection", option DPC</b>						
DN [mm]	A [mm]	B [mm]	C [mm]	D [mm]	E [mm]	L [mm]
1	145	100	4 × Ø22	30	17.3	336
2	145	100	4 × Ø22	30	17.3	413
4	145	100	4 × Ø22	30	17.3	459
Surface roughness (flange): EN 1092-1 Form B1 (DIN 2526 Form C), Ra 3.2 to 12.5 µm						

<b>Flange according to ASME B16.5, Class 150 RF, Schedule 40</b> <b>1.4404 (F316/F316L): order code for "Process connection", option AAS</b> <b>Alloy C22: order code for "Process connection", option AAC</b>						
DN [mm]	A [mm]	B [mm]	C [mm]	D [mm]	E [mm]	L [mm]
1	90	60.3	4 × Ø15.9	11.6	15.7	262
2	90	60.3	4 × Ø15.9	11.6	15.7	339
4	90	60.3	4 × Ø15.9	11.6	15.7	385
Surface roughness (flange): Ra 3.2 to 6.3 µm						

<b>Flange according to ASME B16.5, Class 300 RF, Schedule 40</b> <b>1.4404 (F316/F316L): order code for "Process connection", option ABS</b> <b>Alloy C22: order code for "Process connection", option ABC</b>						
DN [mm]	A [mm]	B [mm]	C [mm]	D [mm]	E [mm]	L [mm]
1	95	66.7	4 × Ø15.9	14.7	15.7	262
2	95	66.7	4 × Ø15.9	14.7	15.7	339
4	95	66.7	4 × Ø15.9	14.7	15.7	385
Surface roughness (flange): Ra 3.2 to 6.3 µm						

<b>Flange according to ASME B16.5, Class 600 RF, Schedule 80</b> <b>1.4404 (F316/F316L): order code for "Process connection", option ACS</b> <b>Alloy C22: order code for "Process connection", option ACC</b>						
DN [mm]	A [mm]	B [mm]	C [mm]	D [mm]	E [mm]	L [mm]
1	95	66.7	4 × Ø15.9	21.3	13.9	292
2	95	66.7	4 × Ø15.9	21.3	13.9	369
4	95	66.7	4 × Ø15.9	21.3	13.9	415
Surface roughness (flange): Ra 3.2 to 6.3 µm						

<b>Flange according to ASME B16.5, Class 900/1500 RF, Schedule 80</b> 1.4404 (F316/F316L): order code for "Process connection", option ARS Alloy C22: order code for "Process connection", option ARC						
<b>Flange according to ASME B16.5, Class 900/1500 RTJ, Schedule 80</b> 1.4404 (F316/F316L): order code for "Process connection", option ASS Alloy C22: order code for "Process connection", option ASC						
DN [mm]	A [mm]	B [mm]	C [mm]	D [mm]	E [mm]	L [mm]
1	120	82.6	4 × Ø22 <sup>1)</sup>	29.3	14	324
2	120	82.6	4 × Ø22 <sup>1)</sup>	29.3	14	401
4	120	82.6	4 × Ø22 <sup>1)</sup>	29.3	14	447
Surface roughness (flange): Ra 3.2 to 6.3 µm						

1) option ARC/ARS: 4 × Ø22.2

<b>Flange according to ASME B16.5, Class 2500 RF, Schedule 80</b> 1.4404 (F316/F316L): order code for "Process connection", option ATS Alloy C22: order code for "Process connection", option ATC						
<b>Flange according to ASME B16.5, Class 2500 RTJ, Schedule 80</b> 1.4404 (F316/F316L): order code for "Process connection", option AUS Alloy C22: order code for "Process connection", option AUC						
DN [mm]	A [mm]	B [mm]	C [mm]	D [mm]	E [mm]	L [mm]
1	135	88.9	4 × Ø22.2	37.2	14	351
2	135	88.9	4 × Ø22.2	37.2	14	428
4	135	88.9	4 × Ø22.2	37.2	14	474
Surface roughness (flange): Ra 3.2 to 6.3 µm						

<b>Flange JIS B2220, 20K</b> 1.4404 (F316/F316L): order code for "Process connection", option NES Alloy C22: order code for "Process connection", option NEC						
DN [mm]	A [mm]	B [mm]	C [mm]	D [mm]	E [mm]	L [mm]
1	95	70	4 × Ø15	14	15	262
2	95	70	4 × Ø15	14	15	339
4	95	70	4 × Ø15	14	15	385
Surface roughness (flange): Ra 3.2 to 6.3 µm						

<b>Flange JIS B2220, 40K</b> 1.4404 (F316/F316L): order code for "Process connection", option NGS Alloy C22: order code for "Process connection", option NGC						
DN [mm]	A [mm]	B [mm]	C [mm]	D [mm]	E [mm]	L [mm]
1	115	80	4 × Ø19	20	15	292
2	115	80	4 × Ø19	20	15	369
4	115	80	4 × Ø19	20	15	415
Surface roughness (flange): Ra 3.2 to 6.3 µm						

<b>Flange JIS B2220, 63K</b>						
1.4404 (F316/F316L): order code for "Process connection", option NHS						
Alloy C22: order code for "Process connection", option NHC						
DN [mm]	A [mm]	B [mm]	C [mm]	D [mm]	E [mm]	L [mm]
1	120	85	4 × Ø19	23	12	312
2	120	85	4 × Ø19	23	12	389
4	120	85	4 × Ø19	23	12	435
Surface roughness (flange): Ra 3.2 to 6.3 µm						

Lap joint flange EN 1092-1, ASME B16.5, JIS B2220

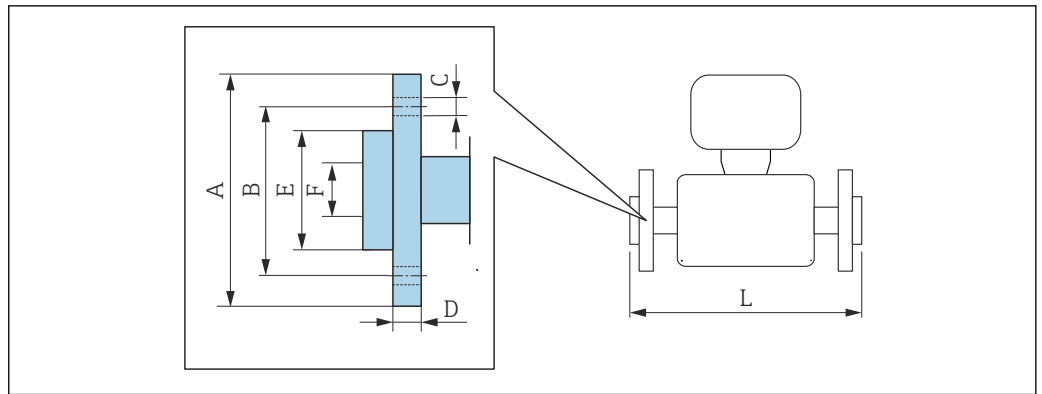

A002221

 Length tolerance for dimension L in mm:  
+1.5 / -2.0

Lap joint flange according to EN 1092-1 Form D: PN 40 1.4301 (F304), wetted parts Alloy C22: order code for "Process connection", option DAC							
DN [mm]	A [mm]	B [mm]	C [mm]	D [mm]	E [mm]	F [mm]	L [mm]
1	95	65	4 × Ø14	14.5	45	17.3	262
2	95	65	4 × Ø14	14.5	45	17.3	339
4	95	65	4 × Ø14	14.5	45	17.3	385

Surface roughness (flange): Ra 3.2 to 12.5 µm

Lap joint flange according to ASME B16.5: Class 150, Schedule 40 1.4301 (F304), wetted parts Alloy C22: order code for "Process connection", option ADC							
DN [mm]	A [mm]	B [mm]	C [mm]	D [mm]	E [mm]	F [mm]	L [mm]
1	90	60.3	4 × Ø15.9	15	35.1	15.7	262
2	90	60.3	4 × Ø15.9	15	35.1	15.7	339
4	90	60.3	4 × Ø15.9	15	35.1	15.7	385

Surface roughness (flange): Ra 3.2 to 12.5 µm

Lap joint flange according to ASME B16.5: Class 300, Schedule 40 1.4301 (F304), wetted parts Alloy C22: order code for "Process connection", option AEC								
DN [mm]	A [mm]	B [mm]	C [mm]	D [mm]	E [mm]	F [mm]	L [mm]	L <sub>diff</sub> <sup>1)</sup> [mm]
1	95	66.7	4 × Ø15.9	16.5	35.1	15.7	268	+6
2	95	66.7	4 × Ø15.9	16.5	35.1	15.7	345	+6
4	95	66.7	4 × Ø15.9	16.5	35.1	15.7	391	+6

Surface roughness (flange): Ra 3.2 to 12.5 µm

1) Difference to installation length of the welding neck flange (order code for "Process connection", option AAC)

Lap joint flange according to ASME B16.5: Class 600, Schedule 80 1.4301 (F304), wetted parts Alloy C22: order code for "Process connection", option AFC							
DN [mm]	A [mm]	B [mm]	C [mm]	D [mm]	E [mm]	F [mm]	L [mm]
1	95	66.7	4 × Ø15.9	17	35.1	13.9	292
2	95	66.7	4 × Ø15.9	17	35.1	13.9	369
4	95	66.7	4 × Ø15.9	17	35.1	13.9	415

Surface roughness (flange): Ra 3.2 to 12.5 µm

Lap joint flange JIS B2220: 20K 1.4301 (F304), wetted parts Alloy C22: order code for "Process connection", option NIC							
DN [mm]	A [mm]	B [mm]	C [mm]	D [mm]	E [mm]	F [mm]	L [mm]
1	95	70	4 × Ø15	14	51	15	262
2	95	70	4 × Ø15	14	51	15	339
4	95	70	4 × Ø15	14	51	15	385

Surface roughness (flange): Ra 3.2 to 12.5 µm

**Accessories**

*Drain connection for rupture disk*

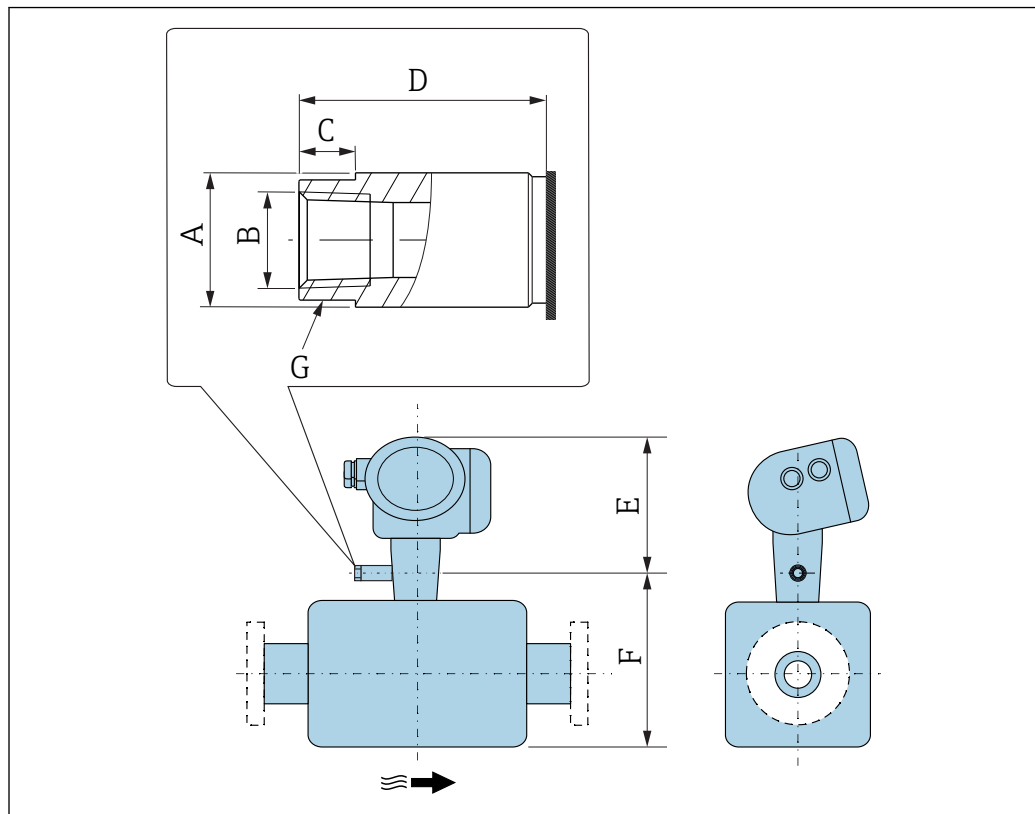

A0043254

DN [mm]	A [mm]	B [in]	C [mm]	D [mm]	E [mm]	F [mm]	G [mm]
1	Ø19	NPT ¼"	8	35	210	123	AF 17
2	Ø19	NPT ¼"	8	35	210	165	AF 17
4	Ø19	NPT ¼"	8	35	210	196	AF 17

Sensor holder

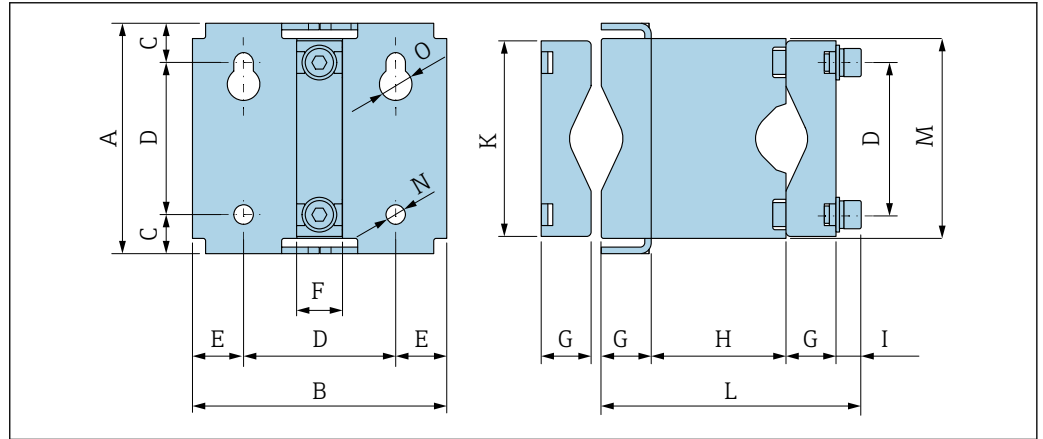

A0036633

A [mm]	B [mm]	C [mm]	D [mm]	E [mm]	F [mm]	G [mm]
106	117	18	70	23.5	21	23

H [mm]	I [mm]	K [mm]	L [mm]	M [mm]	N [mm]	O [mm]
62	12	90	120	92	9	15

Dimensions in US units

Compact version

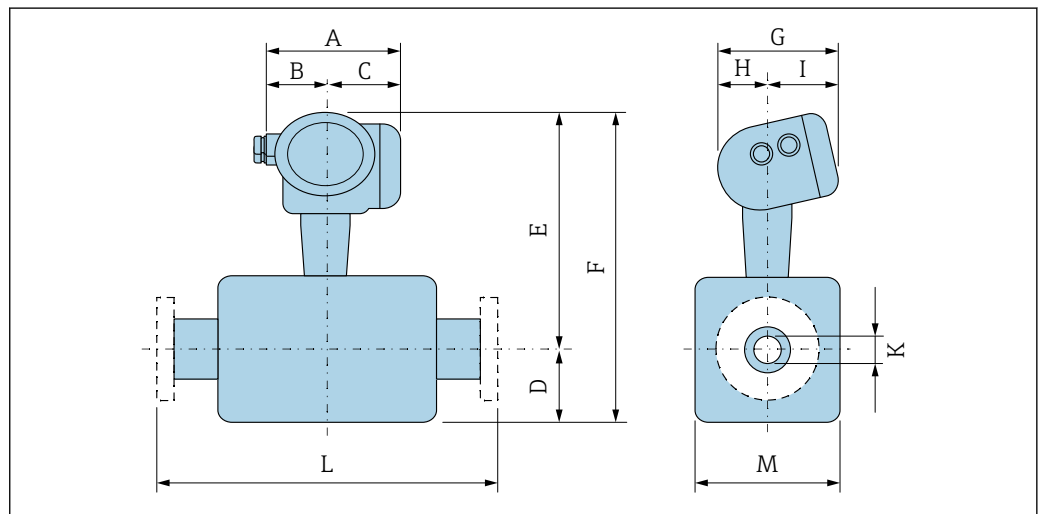

A0033792

Dimensions for version without overvoltage protection

Order code for "Housing", options B "GT18 dual compartment, 316L", C "GT20 dual compartment aluminum coated"

DN [in]	A <sup>1)</sup> [in]	B [in]	C <sup>1)</sup> [in]	D [in]	E <sup>2)</sup> [in]	F <sup>2)</sup> [mm]	G <sup>3)</sup> [in]	H <sup>3)</sup> [in]	I [in]	K [in]	L [in]	M [in]
1/24	6.5	2.95	3.54	2.13	10.98	13.11	6.38	4.02	2.36	0.04	<sup>4)</sup>	1.34
1/12	6.5	2.95	3.54	2.91	11.85	14.76	6.38	4.02	2.36	0.10	<sup>4)</sup>	1.89
1/8	6.5	2.95	3.54	3.54	12.44	15.98	6.38	4.02	2.36	0.15	<sup>4)</sup>	2.01

- 1) For versions with overvoltage protection (OVP): values + 0.31 in
- 2) For version without local display: values - 0.11 in
- 3) For version without local display: values - 0.28 in
- 4) Dependent on respective process connection



**Threaded glands**

*VCO coupling*

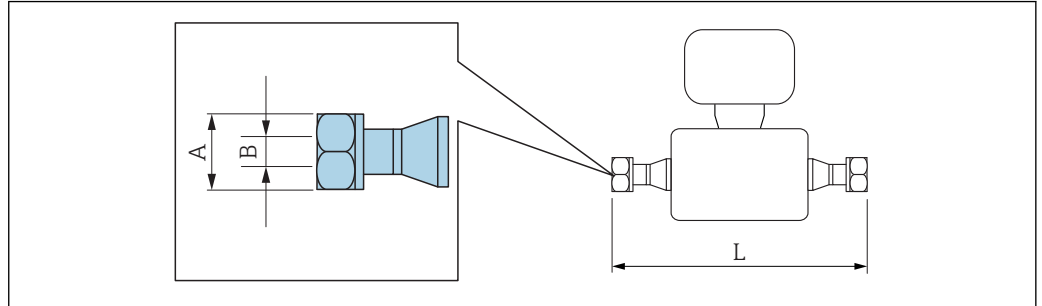

A0015624

**i** Length tolerance for dimension L in inch:  
+0.06 / -0.08

**4-VCO-4**

Order code for "Process connection", option HAW

1.4435 (316/316L): order code for "Measuring tube mat., wetted surface", option BB, BF, SA

Alloy C22: order code for "Measuring tube mat., wetted surface", option HA, HC, HD

Alloy C22, high pressure: order code for "Measuring tube mat., wetted surface", option HB

DN [in]	A [in]	B [in]		L [in]
		Option BB, BF, SA, HA, HC, HD	Option HB	
1/24	AF 11/16	0.04	0.04	7.32
1/12	AF 11/16	0.1	0.08	10.4
1/8	AF 11/16	0.15	0.13	12.2

*G and NPT thread*

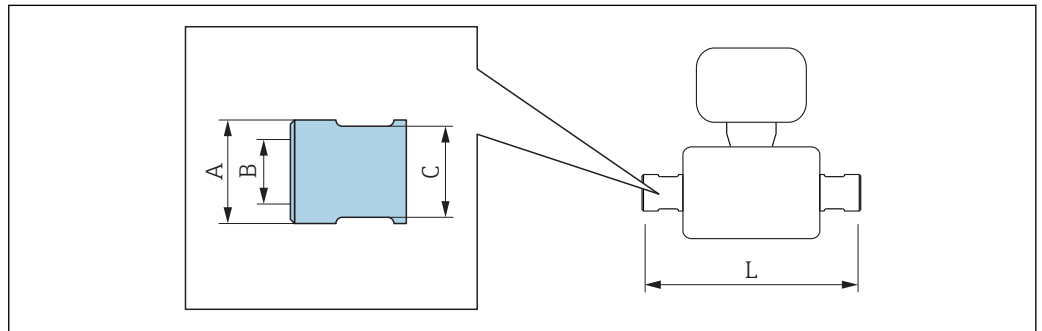

A0036429

**G 1/4 "**

Order code for "Process connection", option G06

1.4404 (316L): order code for "Measuring tube mat., wetted surface", option SA

Alloy C22: order code for "Measuring tube mat., wetted surface", option HA

Alloy C22, high pressure: order code for "Measuring tube mat., wetted surface", option HB

DN [in]	A [in]		B [in]	C [in]	L [in]
	Option HA, SA	Option HB			
1/24	0.89	0.98	G 1/4 "	AF 13/16 "	10.12
1/12	0.89	0.98	G 1/4 "	AF 13/16 "	13.15
1/8	0.89	0.98	G 1/4 "	AF 13/16 "	14.96

**G 1/2 "**  
Order code for "Process connection", option G15  
1.4404 (316L): order code for "Measuring tube mat., wetted surface", option SA  
Alloy C22: order code for "Measuring tube mat., wetted surface", option HA  
Alloy C22, high pressure: order code for "Measuring tube mat., wetted surface", option HB

DN [in]	A [in]		B [in]	C [in]		L [in]	
	Option HA, SA	Option HB		Option HA, SA	Option HB	Option HA, SA	Option HB
1/24	0.89	0.98	G 1/2 "	AF 1 13/16 "	AF 1 3/16 "	11.06	11.02
1/12	0.89	0.98	G 1/2 "	AF 1 13/16 "	AF 1 3/16 "	14.09	14.06
1/8	0.89	0.98	G 1/2 "	AF 1 13/16 "	AF 1 3/16 "	15.91	15.87

**NPT 1/4 "**  
Order code for "Process connection", option P06  
1.4404 (316L): order code for "Measuring tube mat., wetted surface", option SA  
Alloy C22: order code for "Measuring tube mat., wetted surface", option HA  
Alloy C22, high pressure: order code for "Measuring tube mat., wetted surface", option HB

DN [in]	A [in]		B [in]	C [in]	L [in]
	Option HA, SA	Option HB			
1/24	0.89	0.98	NPT 1/4 "	AF 3/4 "	10.12
1/12	0.89	0.98	NPT 1/4 "	AF 3/4 "	13.15
1/8	0.89	0.98	NPT 1/4 "	AF 3/4 "	14.96

**NPT 1/2 "**  
Order code for "Process connection", option P15  
1.4404 (316L): order code for "Measuring tube mat., wetted surface", option SA  
Alloy C22: order code for "Measuring tube mat., wetted surface", option HA  
Alloy C22, high pressure: order code for "Measuring tube mat., wetted surface", option HB

DN [in]	A [in]		B [in]	C [in]		L [in]	
	Option HA, SA	Option HB		Option HA, SA	Option HB	Option HA, SA	Option HB
1/24	0.89	0.98	NPT 1/2 "	AF 1 13/16 "	AF 1 3/16 "	11.06	11.02
1/12	0.89	0.98	NPT 1/2 "	AF 1 13/16 "	AF 1 3/16 "	14.09	14.06
1/8	0.89	0.98	NPT 1/2 "	AF 1 13/16 "	AF 1 3/16 "	15.91	15.87

**Clamp connections**

*Tri-Clamp*

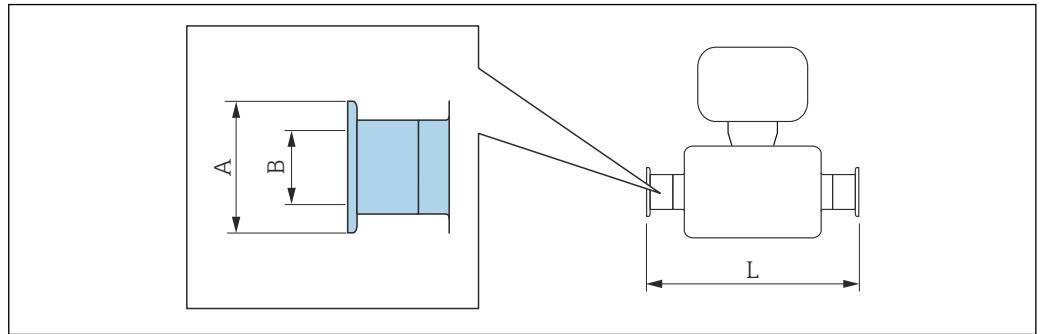

A0015625

 Length tolerance for dimension L in inch:  
+0.06 / -0.08

<b>½" Tri-Clamp</b>			
<b>Order code for "Process connection", option FBW</b>			
<b>1.4435 (316L): order code for "Measuring tube mat., wetted surface", option BB, BF, SA</b>			
<b>Alloy C22: order code for "Measuring tube mat., wetted surface", option HA, HC, HD</b>			
<b>DN</b> <b>[in]</b>	<b>A</b> <b>[in]</b>	<b>B</b> <b>[in]</b>	<b>L</b> <b>[in]</b>
1/24	0.98	0.37	7.56
1/12	0.98	0.37	10.6
1/8	0.98	0.37	12.4

3-A version available (Ra ≤ 0.76 µm/30 µin, Ra ≤ 0.38 µm/15 µin):  
Order code for "Measuring tube mat., wetted surface", option BB, BF, HC, HD in conjunction with order code for "Additional approval", option LP

**Flange connections**

*Fixed flange ASME B16.5*

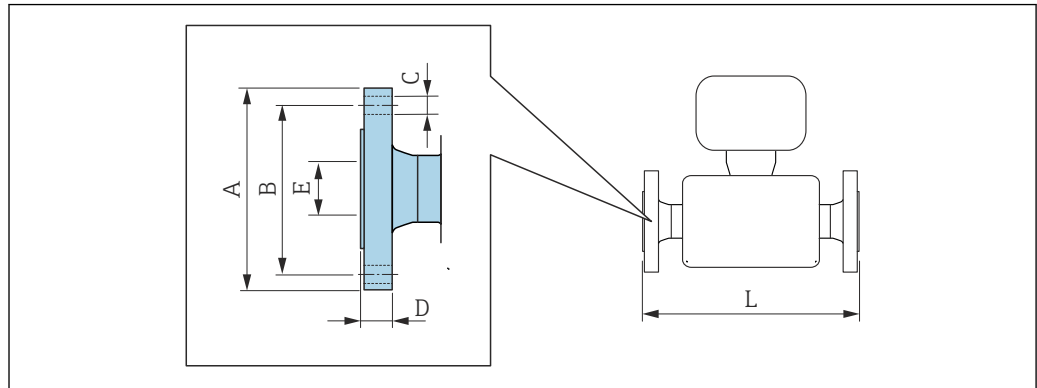

A0015621

**i** Length tolerance for dimension L in inch:  
+0.06 / -0.08

Flange according to ASME B16.5, Class 150 RF, Schedule 40 1.4404 (F316/F316L): order code for "Process connection", option AAS Alloy C22: order code for "Process connection", option AAC						
DN [in]	A [in]	B [in]	C [in]	D [in]	E [in]	L [in]
1/24	3.54	2.37	4 × Ø0.63	0.46	0.62	10.31
1/12	3.54	2.37	4 × Ø0.63	0.46	0.62	13.35
1/8	3.54	2.37	4 × Ø0.63	0.46	0.62	15.16

Surface roughness (flange): Ra 3.2 to 6.3 µm

Flange according to ASME B16.5, Class 300 RF, Schedule 40 1.4404 (F316/F316L): order code for "Process connection", option ABS Alloy C22: order code for "Process connection", option ABC						
DN [in]	A [in]	B [in]	C [in]	D [in]	E [in]	L [in]
1/24	3.74	2.63	4 × Ø0.63	0.58	0.62	10.31
1/12	3.74	2.63	4 × Ø0.63	0.58	0.62	13.35
1/8	3.74	2.63	4 × Ø0.63	0.58	0.62	15.16

Surface roughness (flange): Ra 3.2 to 6.3 µm

Flange according to ASME B16.5, Class 600 RF, Schedule 80 1.4404 (F316/F316L): order code for "Process connection", option ACS Alloy C22: order code for "Process connection", option ACC						
DN [in]	A [in]	B [in]	C [in]	D [in]	E [in]	L [in]
1/24	3.74	2.63	4 × Ø0.63	0.84	0.55	11.5
1/12	3.74	2.63	4 × Ø0.63	0.84	0.55	14.53
1/8	3.74	2.63	4 × Ø0.63	0.84	0.55	16.34

Surface roughness (flange): Ra 3.2 to 6.3 µm

<b>Flange according to ASME B16.5, Class 900/1500 RF, Schedule 80</b> 1.4404 (F316/F316L): order code for "Process connection", option ARS Alloy C22: order code for "Process connection", option ARC						
<b>Flange according to ASME B16.5, Class 900/1500 RTJ, Schedule 80</b> 1.4404 (F316/F316L): order code for "Process connection", option ASS Alloy C22: order code for "Process connection", option ASC						
DN [in]	A [in]	B [in]	C [in]	D [in]	E [in]	L [in]
1/24	4.72	3.25	4 × Ø0.87	1.15	0.55	12.76
1/12	4.72	3.25	4 × Ø0.87	1.15	0.55	15.79
1/8	4.72	3.25	4 × Ø0.87	1.15	0.55	17.6
Surface roughness (flange): Ra 3.2 to 6.3 µm						

<b>Flange according to ASME B16.5, Class 2500 RF, Schedule 80</b> 1.4404 (F316/F316L): order code for "Process connection", option ATS Alloy C22: order code for "Process connection", option ATC						
<b>Flange according to ASME B16.5, Class 2500 RTJ, Schedule 80</b> 1.4404 (F316/F316L): order code for "Process connection", option AUS Alloy C22: order code for "Process connection", option AUC						
DN [in]	A [in]	B [in]	C [in]	D [in]	E [in]	L [in]
1/24	5.31	3.5	4 × Ø0.87	1.46	0.55	13.82
1/12	5.31	3.5	4 × Ø0.87	1.46	0.55	16.85
1/8	5.31	3.5	4 × Ø0.87	1.46	0.55	18.66
Surface roughness (flange): Ra 3.2 to 6.3 µm						

Lap joint flange ASME B16.5

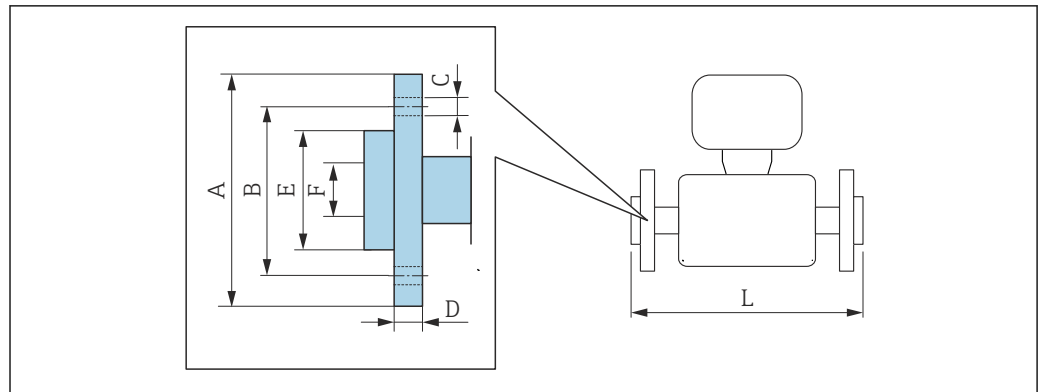

A0022221

**i** Length tolerance for dimension L in mm:  
+1.5 / -2.0

Lap joint flange according to ASME B16.5: Class 150, Schedule 40 1.4301 (F304), wetted parts Alloy C22: order code for "Process connection", option ADC							
DN [in]	A [in]	B [in]	C [in]	D [in]	E [in]	F [in]	L [in]
1/24	3.54	2.37	4 × Ø0.63	0.59	1.65	0.62	10.31
1/12	3.54	2.37	4 × Ø0.63	0.59	1.65	0.62	13.35
1/8	3.54	2.37	4 × Ø0.63	0.59	1.65	0.62	15.16

Surface roughness (flange): Ra 3.2 to 12.5 µm

Lap joint flange according to ASME B16.5: Class 300, Schedule 40 1.4301 (F304), wetted parts Alloy C22: order code for "Process connection", option AEC								
DN [in]	A [in]	B [in]	C [in]	D [in]	E [in]	F [in]	L [in]	L <sub>diff</sub> <sup>1)</sup> [in]
1/24	3.74	2.63	4 × Ø0.63	0.65	1.77	0.62	10.55	0.24
1/12	3.74	2.63	4 × Ø0.63	0.65	1.77	0.62	13.58	0.24
1/8	3.74	2.63	4 × Ø0.63	0.65	1.77	0.62	15.39	0.24

Surface roughness (flange): Ra 3.2 to 12.5 µm

1) Difference to installation length of the welding neck flange (order code for "Process connection", option AAC)

Lap joint flange according to ASME B16.5: Class 600, Schedule 80 1.4301 (F304), wetted parts Alloy C22: order code for "Process connection", option AFC							
DN [in]	A [in]	B [in]	C [in]	D [in]	E [in]	F [in]	L [in]
1/24	3.74	2.63	4 × Ø15.9	0.67	1.89	0.55	11.5
1/12	3.74	2.63	4 × Ø15.9	0.67	1.89	0.55	14.53
1/8	3.74	2.63	4 × Ø15.9	0.67	1.89	0.55	16.34

Surface roughness (flange): Ra 3.2 to 12.5 µm

Accessories

Drain connection for rupture disk

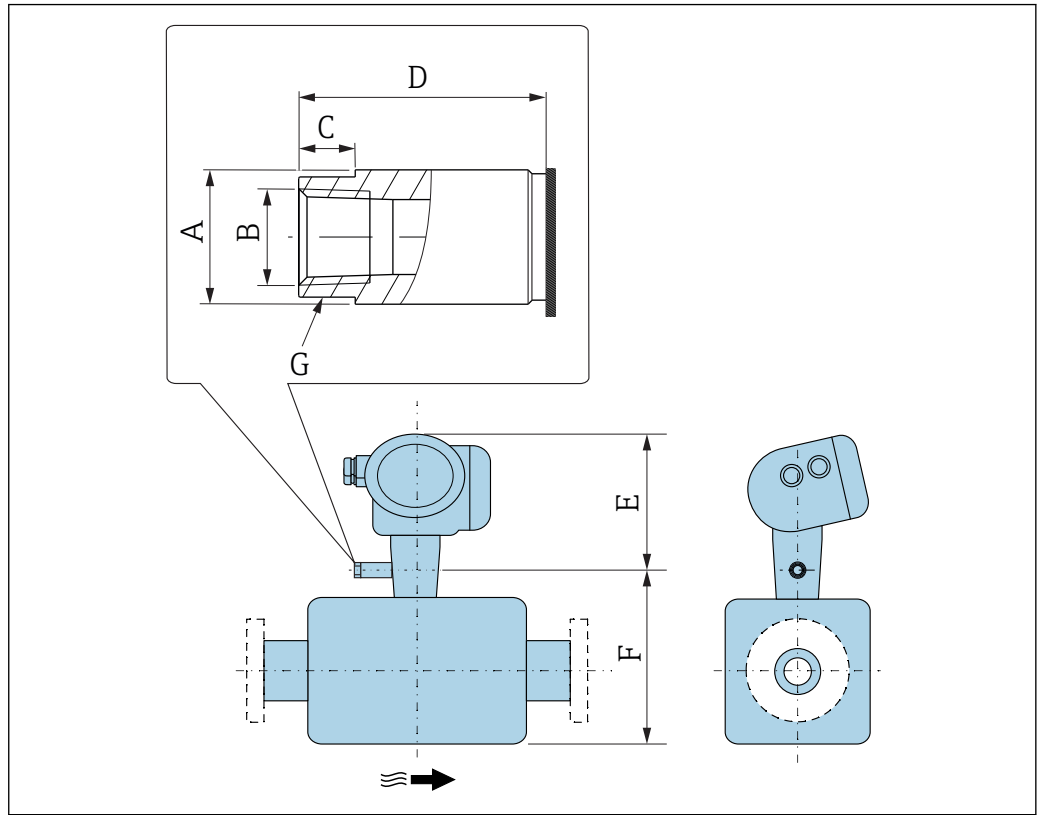

A0043254

DN [in]	A [in]	B [in]	C [in]	D [in]	E [in]	F [in]	G [in]
1/24	Ø0.75	NPT 1/4"	0.31	1.38	8.27	4.84	AF 2/3"
1/12	Ø0.75	NPT 1/4"	0.31	1.38	8.27	6.50	AF 2/3"
1/8	Ø0.75	NPT 1/4"	0.31	1.38	8.27	7.72	AF 2/3"

Sensor holder

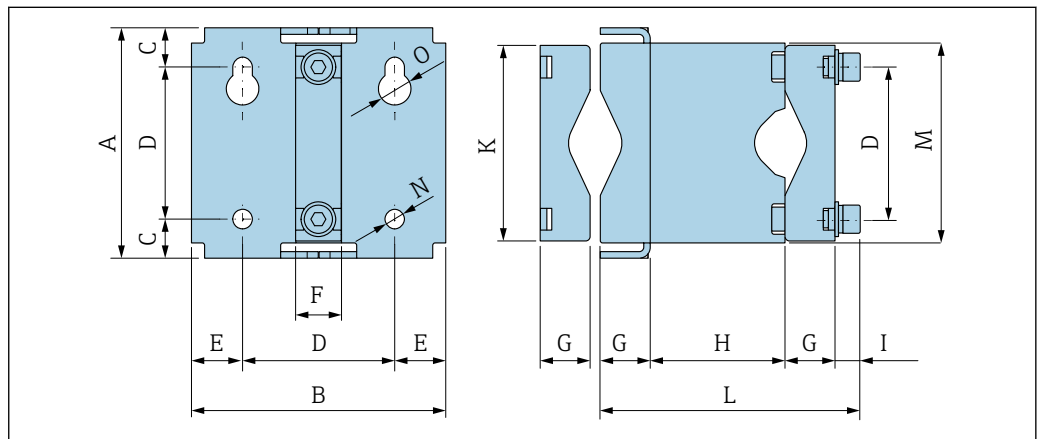

A0036633

A [in]	B [in]	C [in]	D [in]	E [in]	F [in]	G [in]
4.17	4.61	0.71	2.76	0.93	0.83	0.91

H [in]	I [in]	K [in]	L [in]	M [in]	N [in]	O [in]
2.44	0.47	3.54	4.72	3.62	0.35	0.59

**Weight**

All values (weight exclusive of packaging material) refer to devices with EN/DIN PN 40 flanges.

**Weight in SI units**

DN [mm]	Weight [kg]	
	Order code for "Housing", option C "GT20 dual compartment, aluminum, coated, compact"	Order code for "Housing", option B "GT18 dual compartment, 316L, compact"
1	5.5	8.2
2	7.1	9.8
4	9	11.7

**Weight in US units**

DN [in]	Weight [lbs]	
	Order code for "Housing", option C "GT20 dual compartment, aluminum, coated, compact"	Order code for "Housing", option B "GT18 dual compartment, 316L, compact"
1/24	12	18
1/12	16	22
1/8	20	26

**Materials****Transmitter housing**

- Order code for "Housing", option B "Compact, stainless":  
Stainless steel CF-3M (316L, 1.4404)
- Order code for "Housing", option C "Compact, aluminum coated":  
Aluminum, AlSi10Mg, coated
- Window material: glass

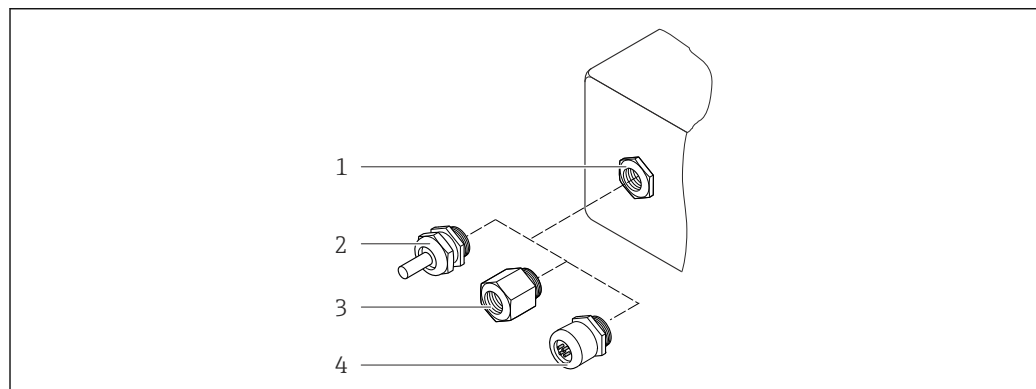
**Cable entries/cable glands**

A0028352

26 Possible cable entries/cable glands

- 1 Female thread M20 × 1.5
- 2 Cable gland M20 × 1.5
- 3 Adapter for cable entry with female thread G ½" or NPT ½"
- 4 Device plugs



Order code for "Housing", option B "GT18 dual compartment, 316L"

Cable entry/cable gland	Type of protection	Material
Cable gland M20 × 1.5	<ul style="list-style-type: none"> <li>▪ Non-Ex</li> <li>▪ Ex ia</li> <li>▪ Ex ic</li> <li>▪ Ex nA</li> <li>▪ Ex tb</li> </ul>	Stainless steel ,1.4404
Adapter for cable entry with female thread G ½"	For non-Ex and Ex (except for CSA Ex d/XP)	Stainless steel, 1.4404 (316L)
Adapter for cable entry with female thread NPT ½"	For non-Ex and Ex	

Order code for "Housing", option C "GT20 dual compartment, aluminum coated"

Cable entry/cable gland	Type of protection	Material
Cable gland M20 × 1.5	<ul style="list-style-type: none"> <li>▪ Non-Ex</li> <li>▪ Ex ia</li> <li>▪ Ex ic</li> </ul>	Plastic
	Adapter for cable entry with female thread G ½"	Nickel-plated brass
Adapter for cable entry with female thread NPT ½"	For non-Ex and Ex (except for CSA Ex d/XP)	Nickel-plated brass
Thread NPT ½" via adapter	For non-Ex and Ex	

**Device plug**

Electrical connection	Material
Plug M12x1	<ul style="list-style-type: none"> <li>▪ Socket: stainless steel, 1.4401/316</li> <li>▪ Contact housing: plastic, PUR, black</li> <li>▪ Contacts: metal, CuZn, gold-plated</li> <li>▪ Threaded connection seal: NBR</li> </ul>

**Sensor housing**

- Acid and alkali-resistant outer surface
- Stainless steel, 1.4404 (316L)

**Measuring tubes**

Order code for "Measuring tube mat., wetted surface", option BB, BF, SA

Stainless steel, 1.4435 (316/316L)

Order code for "Measuring tube mat., wetted surface", option HA, HB, HC, HD

Alloy C22, 2.4602 (UNS N06022)

**Process connections**

Order code for "Measuring tube mat., wetted surface", option SA

VCO coupling	Stainless steel, 1.4404 (316/316L)
G¼", G½" female thread	Stainless steel, 1.4404 (316/316L)
NPT¼", NPT½" female thread	Stainless steel, 1.4404 (316/316L)

<b>Tri-Clamp<math>\frac{1}{2}</math>"</b>	Stainless steel, 1.4435 (316L)
<b>Fixed flange EN 1092-1, ASME B16.5, JIS B2220</b>	Stainless steel, 1.4404 (316/316L)

Order code for "Measuring tube mat., wetted surface", option BB, BF

<b>VCO coupling</b>	Stainless steel, 1.4404 (316/316L)
<b>Tri-Clamp<math>\frac{1}{2}</math>"</b>	Stainless steel, 1.4435 (316L)

Order code for "Measuring tube mat., wetted surface", option HC, HD



<b>VCO coupling</b>	Alloy C22, 2.4602 (UNS N06022)
<b>Tri-Clamp<math>\frac{1}{2}</math>"</b>	Alloy C22, 2.4602 (UNS N06022)

Order code for "Measuring tube mat., wetted surface", option HA

<b>VCO coupling</b>	Alloy C22, 2.4602 (UNS N06022)
<b>G<math>\frac{1}{4}</math>", G<math>\frac{1}{2}</math>" female thread</b>	Alloy C22, 2.4602 (UNS N06022)
<b>NPT<math>\frac{1}{4}</math>", NPT<math>\frac{1}{2}</math>" female thread</b>	Alloy C22, 2.4602 (UNS N06022)
<b>Fixed flange EN 1092-1, ASME B16.5, JIS B2220</b>	Alloy C22, 2.4602 (UNS N06022)
<b>Lap joint flange EN 1092-1, ASME B16.5, JIS B2220</b>	Stainless steel, 1.4301 (F304), wetted parts Alloy C22, 2.4602 (UNS N06022)

Order code for "Measuring tube mat., wetted surface", option HB (high-pressure option)

<b>VCO coupling</b>	Alloy C22, 2.4602 (UNS N06022)
<b>G<math>\frac{1}{4}</math>", G<math>\frac{1}{2}</math>" female thread</b>	Alloy C22, 2.4602 (UNS N06022)
<b>NPT<math>\frac{1}{4}</math>", NPT<math>\frac{1}{2}</math>" female thread</b>	Alloy C22, 2.4602 (UNS N06022)
<b>Fixed flange EN 1092-1, ASME B16.5, JIS B2220</b>	Stainless steel, 1.4404 (316/316L); Alloy C22, 2.4602 (UNS N06022)

 Available process connections →  67

### Seals

Welded process connections without internal seals

### Accessories

#### *Sensor holder*

Stainless steel, 1.4404 (316L)

#### *Heating jacket*

- Heating jacket housing: stainless steel, 1.4571 (316Ti)
- NPT adapter  $\frac{1}{2}$ " : stainless steel, 1.4404 (316)
- G $\frac{1}{2}$ " adapter: stainless steel, 1.4404

*Protective cover*

Stainless steel, 1.4404 (316L)

*Remote display FHX50*

Housing material:

- Plastic PBT
- Stainless steel CF-3M (316L, 1.4404)

**Process connections**

- Fixed flange connections:
  - EN 1092-1 (DIN 2501) flange
  - EN 1092-1 (DIN 2512N) flange
  - ASME B16.5 flange
  - JIS B2220 flange
- Clamp connections:
  - Tri-Clamp (OD tubes), DIN 11866 series C
- VCO connections:
  - 4-VCO-4
- Female thread:
  - Cylindrical female thread BSPP (G) in accordance with ISO 228-1
  - NPT

 Process connection materials →  65

**Surface roughness**

All data relate to parts in contact with fluid. The following surface roughness quality can be ordered.

- Not polished
- Ra<sub>max</sub> = 0.76 µm (30 µin) mechanically polished
- Ra<sub>max</sub> = 0.38 µm (15 µin) mechanically polished

## Operability

**Operating concept**

**Operator-oriented menu structure for user-specific tasks**

- Commissioning
- Operation
- Diagnostics
- Expert level

**Quick and safe commissioning**

- Guided menus ("Make-it-run" wizards) for applications
- Menu guidance with brief explanations of the individual parameter functions

**Reliable operation**

- Operation in the following languages:
  - Via local display:
    - English, German, French, Spanish, Italian, Dutch, Portuguese, Polish, Russian, Swedish, Turkish, Chinese, Japanese, Bahasa (Indonesian), Vietnamese, Czech
  - Via "FieldCare" operating tool:
    - English, German, French, Spanish, Italian, Chinese, Japanese
- Uniform operating philosophy applied to device and operating tools
- If replacing the electronic module, transfer the device configuration via the integrated memory (integrated HistoROM) which contains the process and measuring device data and the event logbook. No need to reconfigure.

**Efficient diagnostics increase measurement availability**

- Troubleshooting measures can be called up via the device and in the operating tools
- Diverse simulation options, logbook for events that occur and optional line recorder functions

**Languages**

Can be operated in the following languages:

- Via local display:
  - English, German, French, Spanish, Italian, Dutch, Portuguese, Polish, Russian, Swedish, Turkish, Chinese, Japanese, Bahasa (Indonesian), Vietnamese, Czech
- Via "FieldCare" operating tool:
  - English, German, French, Spanish, Italian, Chinese, Japanese

**Local operation****Via display module**

Two display modules are available:

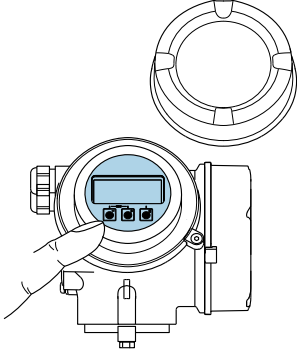
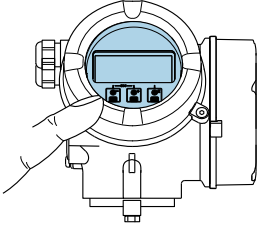
Order code for "Display; Operation", option C "SD02"	Order code for "Display; Operation", option E "SD03"
	
1 Operation with pushbuttons	1 Operation with touch control

*Display elements*

- 4-line, illuminated, graphic display
- White background lighting; switches to red in event of device errors
- Format for displaying measured variables and status variables can be individually configured
- Permitted ambient temperature for the display:  $-20$  to  $+60$  °C ( $-4$  to  $+140$  °F)  
The readability of the display may be impaired at temperatures outside the temperature range.



*Operating elements*

- Operation with 3 push buttons with open housing:  $\oplus$ ,  $\ominus$ ,  $\boxplus$   
or
- External operation via touch control (3 optical keys) without opening the housing:  $\oplus$ ,  $\ominus$ ,  $\boxplus$
- Operating elements also accessible in the various zones of the hazardous area

*Additional functionality*

- Data backup function  
The device configuration can be saved in the display module.
- Data comparison function  
The device configuration saved in the display module can be compared to the current device configuration.
- Data transfer function  
The transmitter configuration can be transmitted to another device using the display module.

**Via remote display FHX50**

 The remote display FHX50 can be ordered as an optional extra →  76.

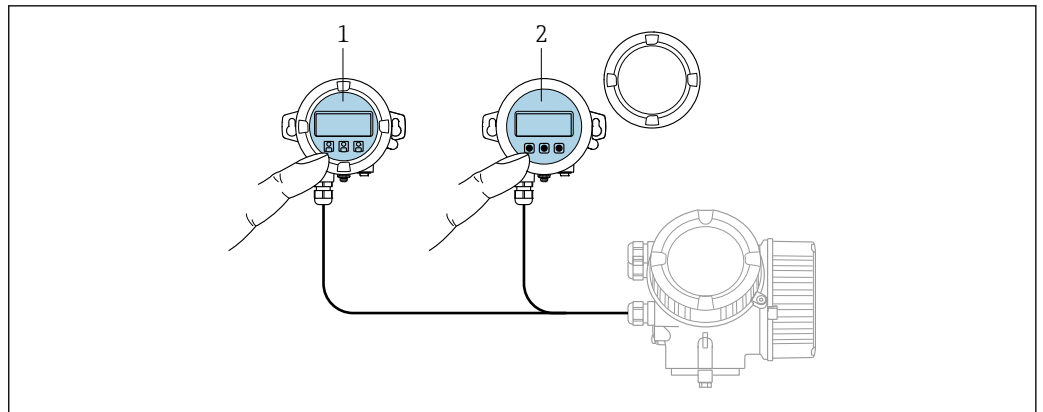

A0032215

27 FHX50 operating options

- 1 SD02 display and operating module, push buttons: cover must be opened for operation
- 2 SD03 display and operating module, optical buttons: operation possible through cover glass

Display and operating elements

The display and operating elements correspond to those of the display module .

Remote operation

Via HART protocol

This communication interface is available in device versions with a HART output.

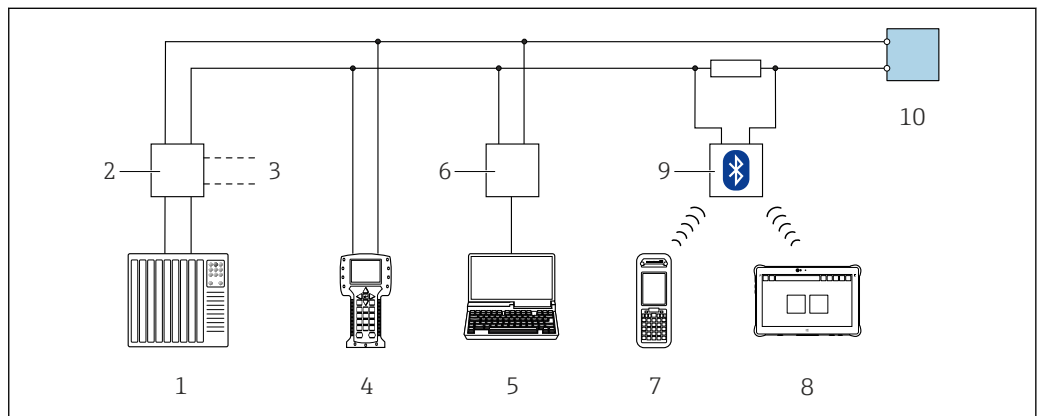

A0028746

28 Options for remote operation via HART protocol (passive)

- 1 Control system (e.g. PLC)
- 2 Transmitter power supply unit, e.g. RN221N (with communication resistor)
- 3 Connection for Commubox FXA195 and Field Communicator 475
- 4 Field Communicator 475
- 5 Computer with web browser (e.g. Internet Explorer) for accessing computers with operating tool (e.g. FieldCare, DeviceCare, AMS Device Manager, SIMATIC PDM) with COM DTM "CDI Communication TCP/IP"
- 6 Commubox FXA195 (USB)
- 7 Field Xpert SFX350 or SFX370
- 8 VIATOR Bluetooth modem with connecting cable
- 9 Transmitter

Via PROFIBUS PA network

This communication interface is available in device versions with PROFIBUS PA.

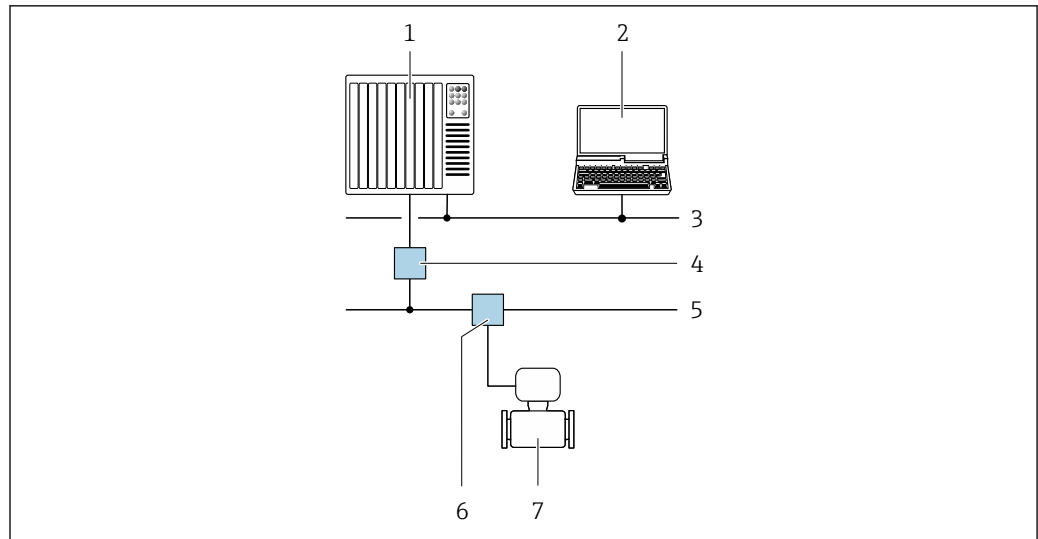

A0028838

29 Options for remote operation via PROFIBUS PA network

- 1 Automation system
- 2 Computer with PROFIBUS network card
- 3 PROFIBUS DP network
- 4 Segment coupler PROFIBUS DP/PA
- 5 PROFIBUS PA network
- 6 T-box
- 7 Measuring device

### Via FOUNDATION Fieldbus network

This communication interface is available in device versions with FOUNDATION Fieldbus.

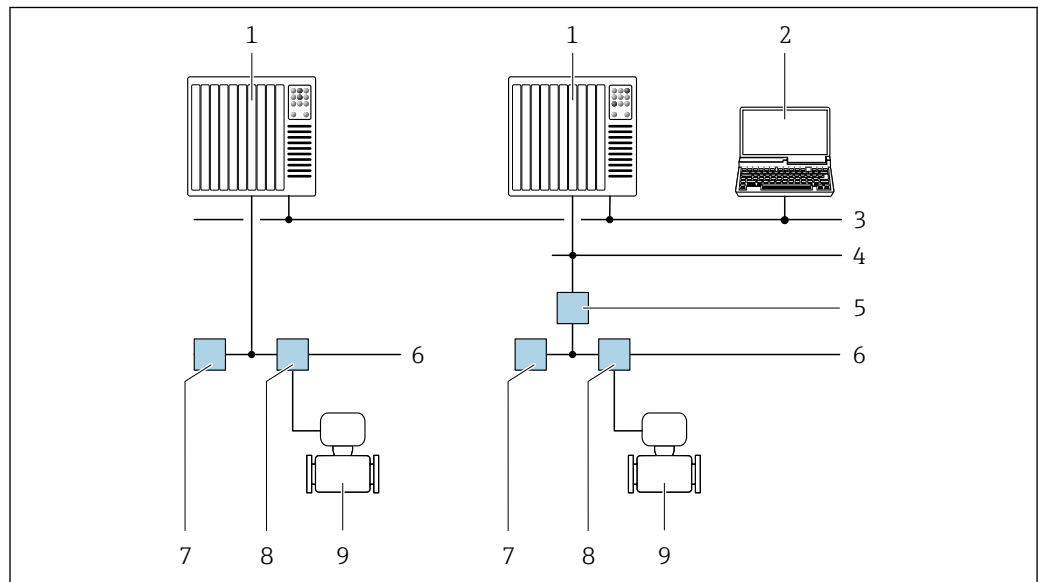

A0028837

30 Options for remote operation via FOUNDATION Fieldbus network

- 1 Automation system
- 2 Computer with FOUNDATION Fieldbus network card
- 3 Industry network
- 4 High Speed Ethernet FF-HSE network
- 5 Segment coupler FF-HSE/FF-H1
- 6 FOUNDATION Fieldbus FF-H1 network
- 7 Power supply FF-H1 network
- 8 T-box
- 9 Measuring device

Service interface

Via service interface (CDI)

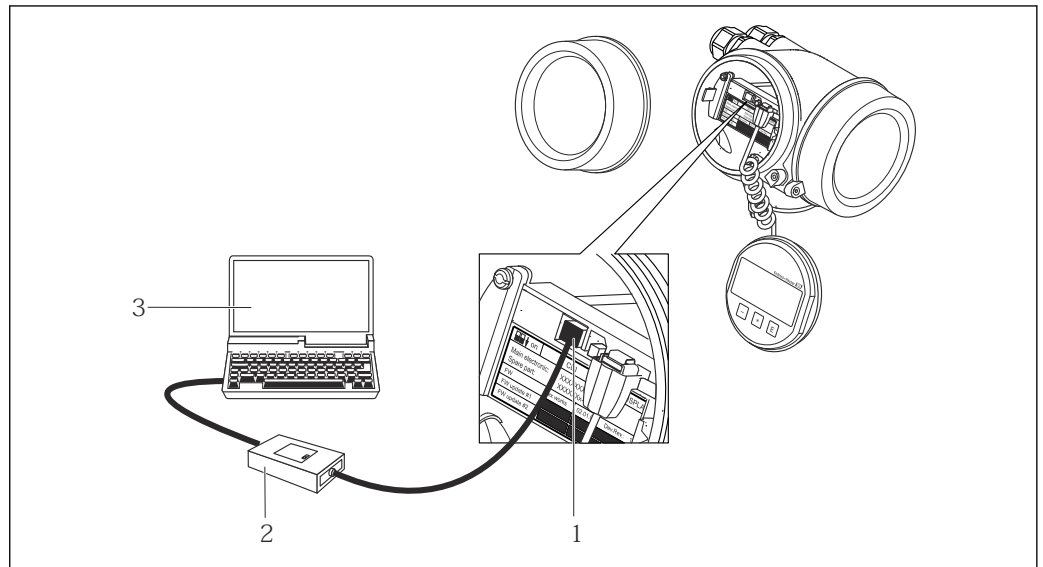

- 1 Service interface (CDI = Endress+Hauser Common Data Interface) of the measuring device
- 2 Commubox FXA291
- 3 Computer with FieldCare operating tool with COM DTM CDI Communication FXA291

A0014019

## Certificates and approvals

 Currently available certificates and approvals can be called up via the product configurator.

**CE mark**

The device meets the legal requirements of the applicable EU Directives. These are listed in the corresponding EU Declaration of Conformity along with the standards applied.

Endress+Hauser confirms successful testing of the device by affixing to it the CE mark.

**RCM-tick symbol**



The measuring system meets the EMC requirements of the "Australian Communications and Media Authority (ACMA)".

**Functional safety**

The measuring device can be used for flow monitoring systems (min., max., range) up to SIL 2 (single-channel architecture; order code for "Additional approval", option LA) and SIL 3 (multichannel architecture with homogeneous redundancy) and is independently evaluated and certified by the TÜV in accordance with IEC 61508.

The following types of monitoring in safety equipment are possible:

- Mass flow
- Volume flow
- Density

 Functional Safety Manual with information on the SIL device →  79

**Ex approval**

The measuring device is certified for use in hazardous areas and the relevant safety instructions are provided in the separate "Safety Instructions" (XA) document. Reference is made to this document on the nameplate.

 The separate Ex documentation (XA) containing all the relevant explosion protection data is available from your Endress+Hauser sales center.

**ATEX/IECEx**

Currently, the following versions for use in hazardous areas are available:

*Ex d*

Category (ATEX)	Type of protection
II2G	Ex d[ia] IIC T6...T1 Gb
II1/2G	Ex d[ia] IIC T6...T1 Ga/Gb <sup>1)</sup>
II1/2G, II2D	Ex d[ia] IIC T6...T1 Ga/Gb <sup>1)</sup> Ex tb IIIC Txx °C Db

1) The following applies for sensors with nominal diameter DN 01: Ex db eb ia IIC T6...T1 Gb

*Ex ia*

Category (ATEX)	Type of protection
II2G	Ex ia IIC T6...T1 Gb
II1/2G	Ex ia IIC T6...T1 Ga/Gb <sup>1)</sup>
II1/2G, II2D	Ex ia IIC T6...T1 Ga/Gb <sup>1)</sup> Ex tb IIIC Txx °C Db

1) The following applies for sensors with nominal diameter DN 01: Ex db eb ia IIC T6...T1 Gb

*Ex nA*

Category (ATEX)	Type of protection
II3G	Ex nA IIC T6...T1 Gc

*Ex ic*

Category (ATEX)	Type of protection
II3G	Ex ic IIC T6...T1 Gc
II1/3G	Ex ic[ia] IIC T6...T1 Ga/Gc

**cCSA<sub>US</sub>**

Currently, the following versions for use in hazardous areas are available:

*IS (Ex i) and XP (Ex d)*

Class I, II, III Division 1 Groups ABCDEFG



*NI (Ex nA, Ex nL)*

- Class I Division 2 Groups ABCD
- Class II, III Division 1 Groups EFG

**Sanitary compatibility**

- 3-A approval
  - Only measuring devices with the order code for "Additional approval", option LP "3A" have 3-A approval.
  - The 3-A approval refers to the measuring device.
  - When installing the measuring device, ensure that no liquid can accumulate on the outside of the measuring device.  
Remote transmitters must be installed in accordance with the 3-A Standard.
  - Accessories (e.g. heating jacket, weather protection cover, wall holder unit) must be installed in accordance with the 3-A Standard.  
Each accessory can be cleaned. Disassembly may be necessary under certain circumstances.
- FDA
- Food Contact Materials Regulation (EC) 1935/2004



<b>Pharmaceutical compatibility</b>	<ul style="list-style-type: none"> <li>■ FDA 21 CFR 177</li> <li>■ USP &lt;87&gt;</li> <li>■ USP &lt;88&gt; Class VI 121 °C</li> <li>■ TSE/BSE Certificate of Suitability</li> <li>■ cGMP</li> </ul> <p> Devices with order code for "Test, certificate", option JG "Compliance with requirements derived from cGMP, declaration" are in accordance with cGMP requirements relating to the surfaces of wetted parts, design, FDA 21 CFR material conformity, USP Class VI tests and TSE/BSE-compliance.</p> <p>A manufacturer's declaration specific to the serial number is supplied with the device.</p>
<b>Functional safety</b>	<p>The measuring device can be used for flow monitoring systems (min., max., range) up to SIL 2 (single-channel architecture; order code for "Additional approval", option LA) and SIL 3 (multichannel architecture with homogeneous redundancy) and is independently evaluated and certified by the TÜV in accordance with IEC 61508.</p> <p>The following types of monitoring in safety equipment are possible:</p> <ul style="list-style-type: none"> <li>■ Mass flow</li> <li>■ Volume flow</li> <li>■ Density</li> </ul> <p> Functional Safety Manual with information on the SIL device →  79</p>
<b>HART certification</b>	<p><b>HART interface</b></p> <p>The measuring device is certified and registered by the FieldComm Group. The measuring system meets all the requirements of the following specifications:</p> <ul style="list-style-type: none"> <li>■ Certified according to HART 7</li> <li>■ The device can also be operated with certified devices of other manufacturers (interoperability)</li> </ul>
<b>FOUNDATION Fieldbus certification</b>	<p><b>FOUNDATION Fieldbus interface</b></p> <p>The measuring device is certified and registered by the FieldComm Group. The measuring system meets all the requirements of the following specifications:</p> <ul style="list-style-type: none"> <li>■ Certified in accordance with FOUNDATION Fieldbus H1</li> <li>■ Interoperability Test Kit (ITK), revision version 6.1.1 (certificate available on request)</li> <li>■ Physical Layer Conformance Test</li> <li>■ The device can also be operated with certified devices of other manufacturers (interoperability)</li> </ul>
<b>Certification PROFIBUS</b>	<p><b>PROFIBUS interface</b></p> <p>The measuring device is certified and registered by the PNO (PROFIBUS User Organization Organization). The measuring system meets all the requirements of the following specifications:</p> <ul style="list-style-type: none"> <li>■ Certified in accordance with PROFIBUS PA Profile 3.02</li> <li>■ The device can also be operated with certified devices of other manufacturers (interoperability)</li> </ul>
<b>Additional certification</b>	<p><b>CRN approval</b></p> <p>Some device versions have CRN approval. A CRN-approved process connection with a CSA approval must be ordered for a CRN-approved device.</p> <p><b>Tests and certificates</b></p> <ul style="list-style-type: none"> <li>■ EN10204-3.1 material certificate, parts and sensor housing in contact with medium</li> <li>■ Pressure testing, internal procedure, inspection certificate</li> <li>■ NACE MR0175 / ISO 15156</li> <li>■ NACE MR0103 / ISO 17945</li> </ul>

*Testing of welded connections*

Option	Test standard				Process connection
	ISO 10675-1 AL1	ASME B31.3 NFS	ASME VIII Div.1	NORSOK M-601	
KE	x				RT
KI		x			RT
KN			x		RT
KS				x	RT
K5	x				DR
K6		x			DR
K7			x		DR
K8				x	DR
RT = Radiographic testing, DR = Digital radiography All options with test report					

**Other standards and guidelines**

- EN 60529  
Degrees of protection provided by enclosures (IP code)
- IEC/EN 60068-2-6  
Environmental influences: Test procedure - Test Fc: vibrate (sinusoidal).
- IEC/EN 60068-2-31  
Environmental influences: Test procedure - Test Ec: shocks due to rough handling, primarily for devices.
- EN 61010-1  
Safety requirements for electrical equipment for measurement, control and laboratory use - general requirements
- IEC/EN 61326  
Emission in accordance with Class A requirements. Electromagnetic compatibility (EMC requirements).
- IEC 61508  
Functional safety of electrical/electronic/programmable electronic safety-related systems
- NAMUR NE 21  
Electromagnetic compatibility (EMC) of industrial process and laboratory control equipment
- NAMUR NE 32  
Data retention in the event of a power failure in field and control instruments with microprocessors
- NAMUR NE 43  
Standardization of the signal level for the breakdown information of digital transmitters with analog output signal.
- NAMUR NE 53  
Software of field devices and signal-processing devices with digital electronics
- NAMUR NE 105  
Specifications for integrating fieldbus devices in engineering tools for field devices
- NAMUR NE 107  
Self-monitoring and diagnosis of field devices
- NAMUR NE 131  
Requirements for field devices for standard applications
- NAMUR NE 132  
Coriolis mass meter

**Ordering information**

Detailed ordering information is available for your nearest sales organization [www.addresses.endress.com](http://www.addresses.endress.com) or in the Product Configurator under [www.endress.com](http://www.endress.com) :

1. Click Corporate
2. Select the country
3. Click Products

4. Select the product using the filters and search field
5. Open the product page

The Configuration button to the right of the product image opens the Product Configurator.



**Product Configurator - the tool for individual product configuration**

- Up-to-the-minute configuration data
- Depending on the device: Direct input of measuring point-specific information such as measuring range or operating language
- Automatic verification of exclusion criteria
- Automatic creation of the order code and its breakdown in PDF or Excel output format
- Ability to order directly in the Endress+Hauser Online Shop

## Application packages

Many different application packages are available to enhance the functionality of the device. Such packages might be needed to address safety aspects or specific application requirements.

The application packages can be ordered with the device or subsequently from Endress+Hauser. Detailed information on the order code in question is available from your local Endress+Hauser sales center or on the product page of the Endress+Hauser website: [www.endress.com](http://www.endress.com).



Detailed information on the application packages:  
Special Documentation for the device → 79





Diagnostics functions	Package	Description
	Extended HistoROM	Comprises extended functions concerning the event log and the activation of the measured value memory.  Event log: Memory volume is extended from 20 message entries (standard version) to up to 100 entries.  Data logging (line recorder): <ul style="list-style-type: none"> <li>▪ Memory capacity for up to 1000 measured values is activated.</li> <li>▪ 250 measured values can be output via each of the 4 memory channels. The recording interval can be defined and configured by the user.</li> <li>▪ Measured value logs can be accessed via the local display or operating tool e.g. FieldCare, DeviceCare or Web server.</li> </ul>
Heartbeat Technology	Package	Description
	Heartbeat Verification	<b>Heartbeat Verification</b> Meets the requirement for traceable verification to DIN ISO 9001:2008 Chapter 7.6 a) "Control of monitoring and measuring equipment". <ul style="list-style-type: none"> <li>▪ Functional testing in the installed state without interrupting the process.</li> <li>▪ Traceable verification results on request, including a report.</li> <li>▪ Simple testing process via local operation or other operating interfaces.</li> <li>▪ Clear measuring point assessment (pass/fail) with high test coverage within the framework of manufacturer specifications.</li> <li>▪ Extension of calibration intervals according to operator's risk assessment.</li> </ul>
Special density	Package	Description
	Special density	Many applications use density as a key measured value for monitoring quality or controlling processes. The device measures the density of the fluid as standard and makes this value available to the control system.  The "Special Density" application package offers high-precision density measurement over a wide density and temperature range particularly for applications subject to varying process conditions.

## Accessories



Various accessories, which can be ordered with the device or subsequently from Endress+Hauser, are available for the device. Detailed information on the order code in question is available from your local Endress+Hauser sales center or on the product page of the Endress+Hauser website: [www.endress.com](http://www.endress.com).

### Device-specific accessories







### For the transmitter

Accessories	Description
Promass 200 transmitter	<p>Transmitter for replacement or storage. Use the order code to define the following specifications:</p> <ul style="list-style-type: none"> <li>▪ Approvals</li> <li>▪ Output</li> <li>▪ Display/operation</li> <li>▪ Housing</li> <li>▪ Software</li> </ul> <p> Installation Instructions EA00104D</p> <p> (Order number: 8X2CXX)</p>
Remote display FHX50	<p>FHX50 housing for accommodating a display module .</p> <ul style="list-style-type: none"> <li>▪ FHX50 housing suitable for: <ul style="list-style-type: none"> <li>▪ SD02 display module (push buttons)</li> <li>▪ SD03 display module (touch control)</li> </ul> </li> <li>▪ Length of connecting cable: up to max. 60 m (196 ft) (cable lengths available for order: 5 m (16 ft), 10 m (32 ft), 20 m (65 ft), 30 m (98 ft))</li> </ul> <p>The measuring device can be ordered with the FHX50 housing and a display module. The following options must be selected in the separate order codes:</p> <ul style="list-style-type: none"> <li>▪ Order code for measuring device, feature 030: Option L or M "Prepared for FHX50 display"</li> <li>▪ Order code for FHX50 housing, feature 050 (device version): Option A "Prepared for FHX50 display"</li> <li>▪ Order code for FHX50 housing, depends on the desired display module in feature 020 (display, operation): <ul style="list-style-type: none"> <li>▪ Option C: for an SD02 display module (push buttons)</li> <li>▪ Option E: for an SD03 display module (touch control)</li> </ul> </li> </ul> <p>The FHX50 housing can also be ordered as a retrofit kit. The measuring device display module is used in the FHX50 housing. The following options must be selected in the order code for the FHX50 housing:</p> <ul style="list-style-type: none"> <li>▪ Feature 050 (measuring device version): option B "Not prepared for FHX50 display"</li> <li>▪ Feature 020 (display, operation): option A "None, existing displayed used"</li> </ul> <p> Special Documentation SD01007F</p> <p>(Order number: FHX50)</p>
Overvoltage protection for 2-wire devices	<p>Ideally, the overvoltage protection module should be ordered directly with the device. See product structure, feature 610 "Accessory mounted", option NA "Overvoltage protection". Separate order necessary only if retrofitting.</p> <ul style="list-style-type: none"> <li>▪ OVP10: For 1-channel devices (feature 020, option A):</li> <li>▪ OVP20: For 2-channel devices (feature 020, options B, C, E or G)</li> </ul> <p> Special Documentation SD01090F</p> <p>(Order number OVP10: 71128617) (Order number OVP20: 71128619)</p>
Protective cover	<p>Is used to protect the measuring device from the effects of the weather: e.g. rainwater, excess heating from direct sunlight or extreme cold in winter.</p> <p> Special Documentation SD00333F</p> <p>(Order number: 71162242)</p>



**For the sensor**

Accessories	Description
Heating jacket	<p>Is used to stabilize the temperature of the fluids in the sensor. Water, water vapor and other non-corrosive liquids are permitted for use as fluids.</p> <p> If using oil as a heating medium, please consult with Endress+Hauser.</p> <ul style="list-style-type: none"> <li>▪ If ordered together with the measuring device:                             <ul style="list-style-type: none"> <li>order code for "Enclosed accessories"                                     <ul style="list-style-type: none"> <li>▪ Option RB "heating jacket, G 1/2" internal thread"</li> <li>▪ Option RD "Heating jacket, NPT 1/2" internal thread"</li> </ul> </li> </ul> </li> <li>▪ If ordered subsequently:                             <ul style="list-style-type: none"> <li>Use the order code with the product root DK8003.</li> </ul> </li> </ul> <p> Special Documentation SD02173D</p>
Sensor holder	<p>For wall, tabletop and pipe mounting.</p> <p> Order number: 71392563</p>





**Communication-specific accessories**

Accessories	Description
Commubox FXA195 HART	<p>For intrinsically safe HART communication with FieldCare via the USB interface.</p> <p> Technical Information TI00404F</p>
Commubox FXA291	<p>Connects Endress+Hauser field devices with a CDI interface (= Endress+Hauser Common Data Interface) and the USB port of a computer or laptop.</p> <p> Technical Information TI405C/07</p>
HART Loop Converter HMX50	<p>Is used to evaluate and convert dynamic HART process variables to analog current signals or limit values.</p> <p> <ul style="list-style-type: none"> <li>▪ Technical Information TI00429F</li> <li>▪ Operating Instructions BA00371F</li> </ul> </p>
Wireless HART adapter SWA70	<p>Is used for the wireless connection of field devices. The WirelessHART adapter can be easily integrated into field devices and existing infrastructures, offers data protection and transmission safety and can be operated in parallel with other wireless networks with minimum cabling complexity.</p> <p> Operating Instructions BA00061S</p>
Fieldgate FXA42	<p>Is used to transmit the measured values of connected 4 to 20 mA analog measuring devices, as well as digital measuring devices</p> <p> <ul style="list-style-type: none"> <li>▪ Technical Information TI01297S</li> <li>▪ Operating Instructions BA01778S</li> <li>▪ Product page: <a href="http://www.endress.com/fxa42">www.endress.com/fxa42</a></li> </ul> </p>
Field Xpert SMT70	<p>The Field Xpert SMT70 tablet PC for device configuration enables mobile plant asset management in hazardous and non-hazardous areas. It is suitable for commissioning and maintenance staff to manage field instruments with a digital communication interface and to record progress. This tablet PC is designed as an all-in-one solution with a preinstalled driver library and is an easy-to-use, touch-sensitive tool which can be used to manage field instruments throughout their entire life cycle.</p> <p> <ul style="list-style-type: none"> <li>▪ Technical Information TI01342S</li> <li>▪ Operating Instructions BA01709S</li> <li>▪ Product page: <a href="http://www.endress.com/smt70">www.endress.com/smt70</a></li> </ul> </p>
Field Xpert SMT77	<p>The Field Xpert SMT77 tablet PC for device configuration enables mobile plant asset management in areas categorized as Ex Zone 1.</p> <p> <ul style="list-style-type: none"> <li>▪ Technical Information TI01418S</li> <li>▪ Operating Instructions BA01923S</li> <li>▪ Product page: <a href="http://www.endress.com/smt77">www.endress.com/smt77</a></li> </ul> </p>

## Service-specific accessories

Accessories	Description
Applicator	<p>Software for selecting and sizing Endress+Hauser measuring devices:</p> <ul style="list-style-type: none"> <li>Choice of measuring devices for industrial requirements</li> <li>Calculation of all the necessary data for identifying the optimum flowmeter: e.g. nominal diameter, pressure loss, flow velocity and accuracy.</li> <li>Graphic illustration of the calculation results</li> <li>Determination of the partial order code, administration, documentation and access to all project-related data and parameters over the entire life cycle of a project.</li> </ul> <p>Applicator is available:</p> <ul style="list-style-type: none"> <li>Via the Internet: <a href="https://portal.endress.com/webapp/applicator">https://portal.endress.com/webapp/applicator</a></li> <li>As a downloadable DVD for local PC installation.</li> </ul>
W@M	<p>W@M Life Cycle Management</p> <p>Improved productivity with information at your fingertips. Data relevant to a plant and its components is generated from the first stages of planning and during the asset's complete life cycle.</p> <p>W@M Life Cycle Management is an open and flexible information platform with online and on-site tools. Instant access for your staff to current, in-depth data shortens your plant's engineering time, speeds up procurement processes and increases plant uptime.</p> <p>Combined with the right services, W@M Life Cycle Management boosts productivity in every phase. For more information, visit <a href="http://www.endress.com/lifecyclemanagement">www.endress.com/lifecyclemanagement</a></p>
FieldCare	<p>FDT-based plant asset management tool from Endress+Hauser. It can configure all smart field units in your system and helps you manage them. By using the status information, it is also a simple but effective way of checking their status and condition.</p> <p> Operating Instructions BA00027S and BA00059S</p>
DeviceCare	<p>Tool to connect and configure Endress+Hauser field devices.</p> <p> Innovation brochure IN01047S</p>

## System components

Accessories	Description
Memograph M graphic data manager	<p>The Memograph M graphic data manager provides information on all the relevant measured variables. Measured values are recorded correctly, limit values are monitored and measuring points analyzed. The data are stored in the 256 MB internal memory and also on a SD card or USB stick.</p> <p> <ul style="list-style-type: none"> <li>Technical Information TI00133R</li> <li>Operating Instructions BA00247R</li> </ul> </p>
RN221N	<p>Active barrier with power supply for safe separation of 4-20 mA standard signal circuits. Offers bidirectional HART transmission.</p> <p> <ul style="list-style-type: none"> <li>Technical Information TI00073R</li> <li>Operating Instructions BA00202R</li> </ul> </p>
RNS221	<p>Supply unit for powering two 2-wire measuring devices solely in the non-hazardous area. Bidirectional communication is possible via the HART communication jacks.</p> <p> <ul style="list-style-type: none"> <li>Technical Information TI00081R</li> <li>Brief Operating Instructions KA00110R</li> </ul> </p>
Cerabar M	<p>The pressure transmitter for measuring the absolute and gauge pressure of gases, steam and liquids. It can be used to read in the operating pressure value.</p> <p> <ul style="list-style-type: none"> <li>Technical Information TI00426P and TI00436P</li> <li>Operating Instructions BA00200P and BA00382P</li> </ul> </p>
Cerabar S	<p>The pressure transmitter for measuring the absolute and gauge pressure of gases, steam and liquids. It can be used to read in the operating pressure value.</p> <p> <ul style="list-style-type: none"> <li>Technical Information TI00383P</li> <li>Operating Instructions BA00271P</li> </ul> </p>

## Supplementary documentation



For an overview of the scope of the associated Technical Documentation, refer to the following:

- *W@M Device Viewer* ([www.endress.com/deviceviewer](http://www.endress.com/deviceviewer)): Enter the serial number from nameplate
- *Endress+Hauser Operations App*: Enter the serial number from the nameplate or scan the 2D matrix code (QR code) on the nameplate

### Standard documentation

### Brief Operating Instructions

*Brief Operating Instructions for the sensor*

Measuring device	Documentation code
Proline Promass A	KA01282D

*Brief Operating Instructions for transmitter*

Measuring device	Documentation code		
	HART	FOUNDATION Fieldbus	PROFIBUS PA
Proline Promass 200	KA012268	KA01267D	KA01269D

### Operating Instructions

Measuring device	Documentation code		
	HART	FOUNDATION Fieldbus	PROFIBUS PA
Proline Promass A 200	BA01821D	BA01827D	BA01828D

### Description of Device Parameters

Measuring device	Documentation code		
	HART	FOUNDATION Fieldbus	PROFIBUS PA
Proline Promass 200	GP01010D	GP01030D	GP01029D

### Supplementary device-dependent documentation

### Safety instructions

Contents	Documentation code
ATEX/IECEX Ex i	XA00144D
ATEX/IECEX Ex d	XA00143D
ATEX/IECEX Ex nA	XA00145D
cCSAus IS	XA00151D
cCSAus XP	XA00152D
INMETRO Ex i	XA01300D
INMETRO Ex d	XA01305D
INMETRO Ex nA	XA01306D
NEPSI Ex i	XA00156D
NEPSI Ex d	XA00155D
NEPSI Ex nA	XA00157D
NEPSI Ex i	XA1755D
NEPSI Ex d	XA1754D

Contents	Documentation code
NEPSI Ex nA	XA1756D
JPN Ex d	XA01763D

### Special Documentation

Contents	Documentation code
Information on the Pressure Equipment Directive	SD01614D
Functional Safety Manual	SD00147D
Display and operating module FHX50	SD01007F

Contents	Documentation		
	HART	FOUNDATION Fieldbus	PROFIBUS PA
Heartbeat Technology	SD01849D	SD01848D	SD01850D

### Installation Instructions

Contents	Comment
Installation instructions for spare part sets and accessories	Documentation code: specified for each individual accessory → 76.

## Registered trademarks

### HART®

Registered trademark of the FieldComm Group, Austin, Texas, USA

### PROFIBUS®

Registered trademark of the PROFIBUS User Organization, Karlsruhe, Germany

### FOUNDATION™ Fieldbus

Registration-pending trademark of the FieldComm Group, Austin, Texas, USA

### TRI-CLAMP®

Registered trademark of Ladish & Co., Inc., Kenosha, USA



---

---

---

[www.addresses.endress.com](http://www.addresses.endress.com)

---