

# Technical Information

## Proline Cubemass C 100

Coriolis flowmeter



Ultra compact for smallest quantities and an ultra-compact transmitter

### Application

- Measuring principle operates independently of physical fluid properties such as viscosity or density
- Accurate measurement of smallest quantities of liquids and gases; ideal for skid integration

### Device properties

- Nominal diameter: DN 1 to 6 ( $\frac{1}{24}$  to  $\frac{1}{4}$ " )
- Process pressure up to 400 bar (5 800 psi)
- Medium temperature up to +205 °C (+401 °F)
- Robust, ultra-compact transmitter housing
- Pre-configured plug connector

### Your benefits

- Space-saving installation – compact single-tube design
- Fewer process measuring points – multivariable measurement (flow, density, temperature)
- Suitable for skids – lightweight sensor
- Space-saving transmitter – full functionality on smallest footprint
- Time-saving local operation without additional software and hardware – integrated web server
- Integrated verification – Heartbeat Technology





## Table of contents

<b>About this document</b> . . . . .	<b>3</b>	Vibration- and shock-resistance . . . . .	47
Symbols . . . . .	3	Interior cleaning . . . . .	48
<b>Function and system design</b> . . . . .	<b>4</b>	Electromagnetic compatibility (EMC) . . . . .	48
Measuring principle . . . . .	4	<b>Process</b> . . . . .	<b>48</b>
Measuring system . . . . .	4	Medium temperature range . . . . .	48
Equipment architecture . . . . .	6	Density . . . . .	49
Safety . . . . .	6	Pressure-temperature ratings . . . . .	49
<b>Input</b> . . . . .	<b>7</b>	Sensor housing . . . . .	50
Measured variable . . . . .	7	Rupture disk . . . . .	50
Measuring range . . . . .	7	Flow limit . . . . .	50
Operable flow range . . . . .	7	Pressure loss . . . . .	50
Input signal . . . . .	8	System pressure . . . . .	51
<b>Output</b> . . . . .	<b>8</b>	Thermal insulation . . . . .	51
Output signal . . . . .	8	Heating . . . . .	51
Signal on alarm . . . . .	10	Vibrations . . . . .	51
Ex connection data . . . . .	11	<b>Mechanical construction</b> . . . . .	<b>52</b>
Low flow cut off . . . . .	12	Dimensions in SI units . . . . .	52
Protocol-specific data . . . . .	12	Dimensions in US units . . . . .	58
<b>Power supply</b> . . . . .	<b>22</b>	Weight . . . . .	63
Terminal assignment . . . . .	22	Materials . . . . .	63
Pin assignment, device plug . . . . .	29	Process connections . . . . .	65
Supply voltage . . . . .	32	Surface roughness . . . . .	65
Power consumption . . . . .	32	<b>Human interface</b> . . . . .	<b>65</b>
Current consumption . . . . .	32	Operating concept . . . . .	65
Power supply failure . . . . .	32	Local display . . . . .	65
Electrical connection . . . . .	33	Remote operation . . . . .	66
Potential equalization . . . . .	37	Service interface . . . . .	68
Terminals . . . . .	37	<b>Certificates and approvals</b> . . . . .	<b>70</b>
Cable entries . . . . .	37	CE mark . . . . .	70
Cable specification . . . . .	37	RCM-tick symbol . . . . .	70
<b>Performance characteristics</b> . . . . .	<b>39</b>	Pressure Equipment Directive . . . . .	70
Reference operating conditions . . . . .	39	Other standards and guidelines . . . . .	70
Maximum measured error . . . . .	39	<b>Ordering information</b> . . . . .	<b>71</b>
Repeatability . . . . .	40	<b>Application packages</b> . . . . .	<b>71</b>
Response time . . . . .	41	Heartbeat Technology . . . . .	72
Influence of ambient temperature . . . . .	41	Concentration . . . . .	72
Influence of medium temperature . . . . .	41	Special density . . . . .	72
Influence of medium pressure . . . . .	42	<b>Accessories</b> . . . . .	<b>72</b>
Design fundamentals . . . . .	42	Device-specific accessories . . . . .	72
<b>Installation</b> . . . . .	<b>43</b>	Communication-specific accessories . . . . .	72
Mounting location . . . . .	43	Service-specific accessories . . . . .	73
Orientation . . . . .	44	System components . . . . .	74
Inlet and outlet runs . . . . .	44	<b>Supplementary documentation</b> . . . . .	<b>74</b>
Special mounting instructions . . . . .	45	Standard documentation . . . . .	74
Installing the Safety Barrier Promass 100 . . . . .	47	Supplementary device-dependent documentation . . . . .	75
<b>Environment</b> . . . . .	<b>47</b>	<b>Registered trademarks</b> . . . . .	<b>75</b>
Ambient temperature range . . . . .	47		
Storage temperature . . . . .	47		
Climate class . . . . .	47		
Degree of protection . . . . .	47		









## About this document

### Symbols



#### Electrical symbols

Symbol	Meaning
	Direct current
	Alternating current
	Direct current and alternating current
	<b>Ground connection</b> A grounded terminal which, as far as the operator is concerned, is grounded via a grounding system.
	<b>Protective Earth (PE)</b> A terminal which must be connected to ground prior to establishing any other connections.  The ground terminals are situated inside and outside the device: <ul style="list-style-type: none"> <li>▪ Inner ground terminal: Connects the protective earth to the mains supply.</li> <li>▪ Outer ground terminal: Connects the device to the plant grounding system.</li> </ul>

#### Symbols for certain types of information

Symbol	Meaning
	<b>Permitted</b> Procedures, processes or actions that are permitted.
	<b>Preferred</b> Procedures, processes or actions that are preferred.
	<b>Forbidden</b> Procedures, processes or actions that are forbidden.
	<b>Tip</b> Indicates additional information.
	Reference to documentation.
	Reference to page.
	Reference to graphic.
	Visual inspection.

#### Symbols in graphics

Symbol	Meaning
1, 2, 3, ...	Item numbers
<b>1</b> , <b>2</b> , <b>3</b> , ...	Series of steps
A, B, C, ...	Views
A-A, B-B, C-C, ...	Sections
	Hazardous area
	Safe area (non-hazardous area)
	Flow direction

## Function and system design

### Measuring principle

The measuring principle is based on the controlled generation of Coriolis forces. These forces are always present in a system when both translational and rotational movements are superimposed.

$$F_c = 2 \cdot \Delta m (v \cdot \omega)$$

$F_c$  = Coriolis force

$\Delta m$  = moving mass

$\omega$  = rotational velocity

$v$  = radial velocity in rotating or oscillating system

The amplitude of the Coriolis force depends on the moving mass  $\Delta m$ , its velocity  $v$  in the system and thus on the mass flow. Instead of a constant rotational velocity  $\omega$ , the sensor uses oscillation.

In the sensor, an oscillation is produced in the measuring tube. The Coriolis forces produced at the measuring tube loop cause a phase shift in the tube oscillations (see illustration):

- If there is zero flow (i.e. when the fluid stands still), the oscillation measured at points A and B has the same phase (no phase difference) (1).
- Mass flow causes deceleration of the oscillation at the inlet of the tubes (2) and acceleration at the outlet (3).

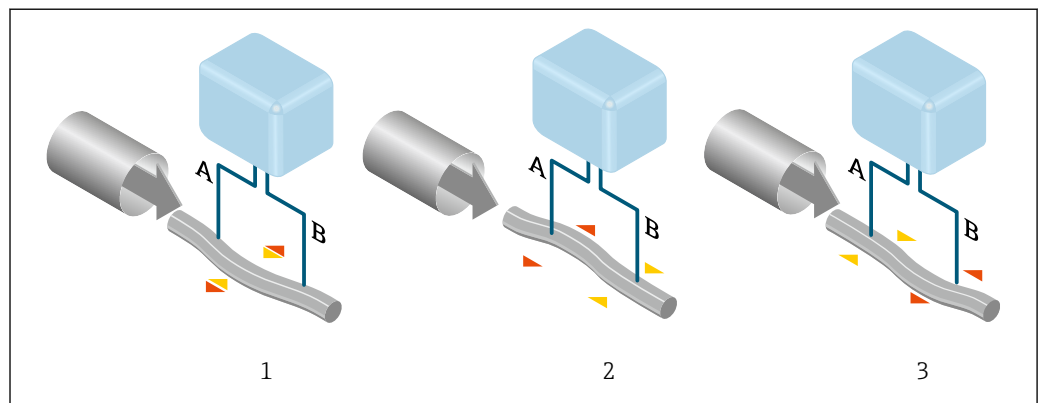

A0029932

The phase difference (A-B) increases with increasing mass flow. Electrodynamic sensors register the tube oscillations at the inlet and outlet. System balance is ensured by the antiphase oscillation of the two measuring tubes. The measuring principle operates independently of temperature, pressure, viscosity, conductivity and flow profile.

#### Density measurement

The measuring tube is continuously excited at its resonance frequency. A change in the mass and thus the density of the oscillating system (comprising measuring tube and fluid) results in a corresponding, automatic adjustment in the oscillation frequency. Resonance frequency is thus a function of medium density. The microprocessor utilizes this relationship to obtain a density signal.

#### Volume measurement

Together with the measured mass flow, this is used to calculate the volume flow.

#### Temperature measurement

The temperature of the measuring tube is determined in order to calculate the compensation factor due to temperature effects. This signal corresponds to the process temperature and is also available as an output signal.

### Measuring system

The device consists of a transmitter and a sensor. If a device with Modbus RS485 intrinsically safe is ordered, the Safety Barrier Promass 100 is part of the scope of supply and must be implemented to operate the device.

The device is available as a compact version:

The transmitter and sensor form a mechanical unit.

**Transmitter**

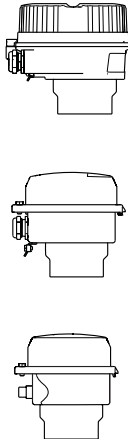
<p><b>Proline 100</b></p>  <p>A0016693</p> <p>A0016694</p> <p>A0016695</p>	<p>Device versions and materials:</p> <ul style="list-style-type: none"> <li>▪ Compact, aluminum, coated: Aluminum, AlSi10Mg, coated</li> <li>▪ Compact, hygienic, stainless: Hygienic version, stainless steel 1.4301 (304)</li> <li>▪ Ultra-compact, hygienic, stainless: Hygienic version, stainless steel 1.4301 (304)</li> </ul> <p>Configuration:</p> <ul style="list-style-type: none"> <li>▪ Via operating tools (e.g. FieldCare, DeviceCare)</li> <li>▪ Also for device version with local display: Via Web browser (e.g. Microsoft Internet Explorer)</li> <li>▪ Also for device version with 4-20 mA HART, pulse/frequency/switch output: Via Web browser (e.g. Microsoft Internet Explorer)</li> <li>▪ Also for device version with EtherNet/IP output:             <ul style="list-style-type: none"> <li>▪ Via Web browser (e.g. Microsoft Internet Explorer)</li> <li>▪ Via Add-on Profile Level 3 for automation system from Rockwell Automation</li> <li>▪ Via Electronic Data Sheet (EDS)</li> </ul> </li> <li>▪ Also for device version with PROFINET output:             <ul style="list-style-type: none"> <li>▪ Via Web browser (e.g. Microsoft Internet Explorer)</li> <li>▪ Via device master file (GSD)</li> </ul> </li> </ul>
---	---

**Sensor**

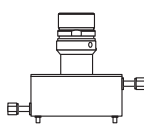
<p><b>Cubemass C</b></p>  <p>A0019546</p>	<p>The ultra compact, bent single-tube system for minimum flow rates and high pressure</p> <ul style="list-style-type: none"> <li>▪ Simultaneous measurement of flow, volume flow, density and temperature (multivariable)</li> <li>▪ Immune to process influences</li> <li>▪ Nominal diameter range: DN 1 to 6 (1/24 to 1/4 ")</li> <li>▪ Materials:             <ul style="list-style-type: none"> <li>▪ Sensor: stainless steel, 1.4301 (304)</li> <li>▪ Measuring tube: stainless steel, 1.4539 (904L)</li> <li>▪ Process connections: stainless steel, 1.4404 (316/316L); 1.4539 (904L)</li> </ul> </li> </ul>
--	---

**Safety Barrier Promass 100**

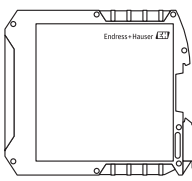
 <p>A0016763</p>	<ul style="list-style-type: none"> <li>▪ Dual-channel safety barrier for installation in non-hazardous locations or zone 2/div. 2:             <ul style="list-style-type: none"> <li>▪ Channel 1: DC 24 V power supply</li> <li>▪ Channel 2: Modbus RS485</li> </ul> </li> <li>▪ In addition to current, voltage and power limitation, it offers galvanic isolation of circuits for explosion protection.</li> <li>▪ Easy top-hat rail mounting (DIN 35 mm) for installation in control cabinets</li> </ul>
---	--

## Equipment architecture

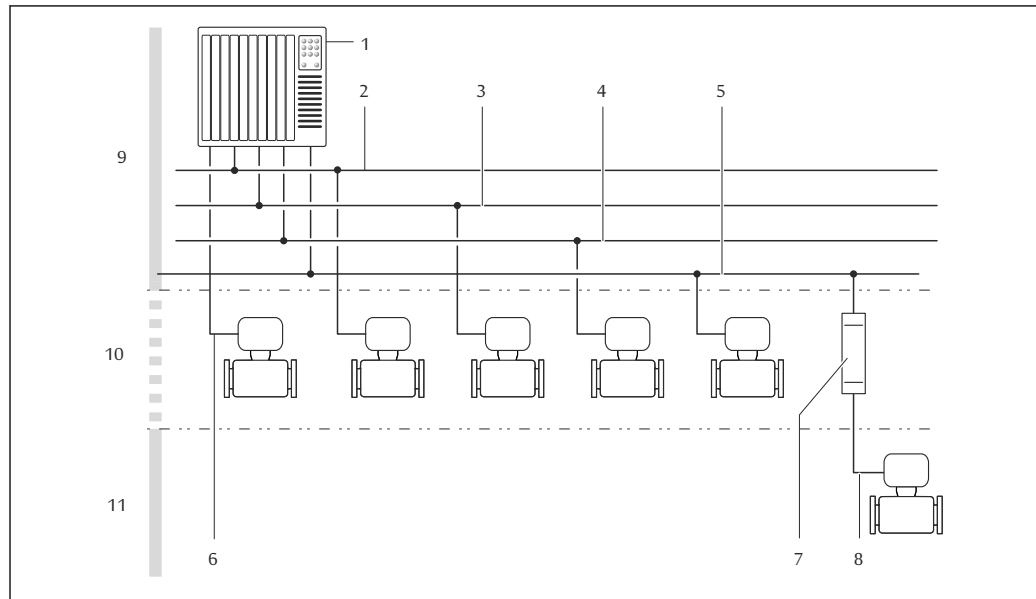

A0016779

1 Possibilities for integrating measuring devices into a system

- 1 Control system (e.g. PLC)
- 2 EtherNet/IP
- 3 PROFIBUS DP
- 4 PROFINET
- 5 Modbus RS485
- 6 4-20 mA HART, pulse/frequency/switch output
- 7 Safety Barrier Promass 100
- 8 Modbus RS485 intrinsically safe
- 9 Non-hazardous area
- 10 Non-hazardous area and Zone 2/Div. 2
- 11 Hazardous area and Zone 1/Div. 1

## Safety

## IT security

Our warranty is valid only if the device is installed and used as described in the Operating Instructions. The device is equipped with security mechanisms to protect it against any inadvertent changes to the settings.

IT security measures, which provide additional protection for the device and associated data transfer, must be implemented by the operators themselves in line with their security standards.

## Input

### Measured variable

#### Direct measured variables

- Mass flow
- Density
- Temperature

#### Calculated measured variables

- Volume flow
- Corrected volume flow
- Reference density

### Measuring range

#### Measuring ranges for liquids

DN		Measuring range full scale values $\dot{m}_{\min(F)}$ to $\dot{m}_{\max(F)}$	
[mm]	[in]	[kg/h]	[lb/min]
1	1/24	0 to 20	0 to 0.735
2	1/12	0 to 100	0 to 3.675
4	1/8	0 to 450	0 to 16.54
6	1/4	0 to 1000	0 to 36.75



#### Measuring ranges for gases

The full scale values depend on the density of the gas and can be calculated with the formula below:

$$\dot{m}_{\max(G)} = \dot{m}_{\max(F)} \cdot \rho_G \cdot x$$

$\dot{m}_{\max(G)}$	Maximum full scale value for gas [kg/h]
$\dot{m}_{\max(F)}$	Maximum full scale value for liquid [kg/h]
$\dot{m}_{\max(G)} < \dot{m}_{\max(F)}$	$\dot{m}_{\max(G)}$ can never be greater than $\dot{m}_{\max(F)}$
$\rho_G$	Gas density in [kg/m <sup>3</sup> ] at operating conditions
x	Constant dependent on nominal diameter

DN		x
[mm]	[in]	[kg/m <sup>3</sup> ]
1	1/24	20
2	1/12	20
4	1/8	20
6	1/4	20

 To calculate the measuring range, use the *Applicator* sizing tool →  73

#### Recommended measuring range

"Flow limit" section →  50

### Operable flow range

Over 1000 : 1.

Flow rates above the preset full scale value do not override the electronics unit, with the result that the totalizer values are registered correctly.

**Input signal****External measured values**

To increase the accuracy of certain measured variables or to calculate the corrected volume flow for gases, the automation system can continuously write different measured values to the measuring device:

- Operating pressure to increase accuracy (Endress+Hauser recommends the use of a pressure measuring device for absolute pressure, e.g. Cerabar M or Cerabar S)
- Medium temperature to increase accuracy (e.g. iTEMP)
- Reference density for calculating the corrected volume flow for gases

 Various pressure transmitters and temperature measuring devices can be ordered from Endress +Hauser: see "Accessories" section →  74

It is recommended to read in external measured values to calculate the following measured variables:

- Mass flow
- Corrected volume flow

*HART protocol*

The measured values are written from the automation system to the measuring device via the HART protocol. The pressure transmitter must support the following protocol-specific functions:

- HART protocol
- Burst mode

*Digital communication*

The measured values can be written from the automation system to the measuring via:

- PROFIBUS DP
- Modbus RS485
- EtherNet/IP
- PROFINET



**Output****Output signal****HART current output**

<b>Current output</b>	4-20 mA HART (active)
<b>Maximum output values</b>	<ul style="list-style-type: none"> <li>▪ DC 24 V (no flow)</li> <li>▪ 22.5 mA</li> </ul>
<b>Load</b>	0 to 700 Ω
<b>Resolution</b>	0.38 μA
<b>Damping</b>	Configurable: 0.07 to 999 s
<b>Assignable measured variables</b>	<ul style="list-style-type: none"> <li>▪ Mass flow</li> <li>▪ Volume flow</li> <li>▪ Corrected volume flow</li> <li>▪ Density</li> <li>▪ Reference density</li> <li>▪ Temperature</li> </ul> <p> The range of options increases if the measuring device has one or more application packages.</p>

**Pulse/frequency/switch output**

<b>Function</b>	Can be set to pulse, frequency or switch output
<b>Version</b>	Passive, open collector
<b>Maximum input values</b>	<ul style="list-style-type: none"> <li>▪ DC 30 V</li> <li>▪ 25 mA</li> </ul>
<b>Voltage drop</b>	For 25 mA: ≤ DC 2 V
<b>Pulse output</b>	



<b>Pulse width</b>	Configurable: 0.05 to 2 000 ms
<b>Maximum pulse rate</b>	10 000 Impulse/s
<b>Pulse value</b>	Adjustable
<b>Assignable measured variables</b>	<ul style="list-style-type: none"> <li>▪ Mass flow</li> <li>▪ Volume flow</li> <li>▪ Corrected volume flow</li> </ul>
<b>Frequency output</b>	
<b>Output frequency</b>	Configurable: 0 to 10 000 Hz
<b>Damping</b>	Configurable: 0 to 999 s
<b>Pulse/pause ratio</b>	1:1
<b>Assignable measured variables</b>	<ul style="list-style-type: none"> <li>▪ Mass flow</li> <li>▪ Volume flow</li> <li>▪ Corrected volume flow</li> <li>▪ Density</li> <li>▪ Reference density</li> <li>▪ Temperature</li> </ul> <p> The range of options increases if the measuring device has one or more application packages.</p>
<b>Switch output</b>	
<b>Switching behavior</b>	Binary, conductive or non-conductive
<b>Switching delay</b>	Configurable: 0 to 100 s
<b>Number of switching cycles</b>	Unlimited
<b>Assignable functions</b>	<ul style="list-style-type: none"> <li>▪ Off</li> <li>▪ On</li> <li>▪ Diagnostic behavior</li> <li>▪ Limit value                             <ul style="list-style-type: none"> <li>▪ Mass flow</li> <li>▪ Volume flow</li> <li>▪ Corrected volume flow</li> <li>▪ Density</li> <li>▪ Reference density</li> <li>▪ Temperature</li> </ul> </li> <li>▪ Totalizer 1-3</li> <li>▪ Flow direction monitoring</li> <li>▪ Status                             <ul style="list-style-type: none"> <li>▪ Partially filled pipe detection</li> <li>▪ Low flow cut off</li> </ul> </li> </ul> <p> The range of options increases if the measuring device has one or more application packages.</p>

**PROFIBUS DP**

<b>Signal encoding</b>	NRZ code
<b>Data transfer</b>	9.6 kBaud...12 MBaud

**Modbus RS485**

<b>Physical interface</b>	In accordance with EIA/TIA-485-A standard
<b>Terminating resistor</b>	<ul style="list-style-type: none"> <li>▪ For device version used in non-hazardous areas or Zone 2/Div. 2: integrated and can be activated via DIP switches on the transmitter electronics module</li> <li>▪ For device version used in intrinsically safe areas: integrated and can be activated via DIP switches on the Safety Barrier Promass 100</li> </ul>

**EtherNet/IP**

<b>Standards</b>	In accordance with IEEE 802.3
------------------	-------------------------------

**PROFINET**

<b>Standards</b>	In accordance with IEEE 802.3
------------------	-------------------------------

**Signal on alarm**

Depending on the interface, failure information is displayed as follows:

**Current output 4 to 20 mA**

*4 to 20 mA*

<b>Failure mode</b>	Choose from: <ul style="list-style-type: none"> <li>▪ 4 to 20 mA in accordance with NAMUR recommendation NE 43</li> <li>▪ 4 to 20 mA in accordance with US</li> <li>▪ Min. value: 3.59 mA</li> <li>▪ Max. value: 22.5 mA</li> <li>▪ Freely definable value between: 3.59 to 22.5 mA</li> <li>▪ Actual value</li> <li>▪ Last valid value</li> </ul>
---------------------	--

**Pulse/frequency/switch output**

<b>Pulse output</b>	
<b>Failure mode</b>	Choose from: <ul style="list-style-type: none"> <li>▪ Actual value</li> <li>▪ No pulses</li> </ul>
<b>Frequency output</b>	
<b>Failure mode</b>	Choose from: <ul style="list-style-type: none"> <li>▪ Actual value</li> <li>▪ 0 Hz</li> <li>▪ Defined value: 0 to 12 500 Hz</li> </ul>
<b>Switch output</b>	
<b>Failure mode</b>	Choose from: <ul style="list-style-type: none"> <li>▪ Current status</li> <li>▪ Open</li> <li>▪ Closed</li> </ul>

**PROFIBUS DP**

<b>Status and alarm messages</b>	Diagnostics in accordance with PROFIBUS PA Profile 3.02
----------------------------------	---

**Modbus RS485**

<b>Failure mode</b>	Choose from: <ul style="list-style-type: none"> <li>▪ NaN value instead of current value</li> <li>▪ Last valid value</li> </ul>
---------------------	---

**EtherNet/IP**

<b>Device diagnostics</b>	Device condition can be read out in Input Assembly
---------------------------	--

**PROFINET**

<b>Device diagnostics</b>	According to "Application Layer protocol for decentralized periphery", Version 2.3
---------------------------	--

**Local display**

<b>Plain text display</b>	With information on cause and remedial measures
<b>Backlight</b>	Red backlighting indicates a device error.



Status signal as per NAMUR recommendation NE 107

**Interface/protocol**

- Via digital communication:
  - HART protocol
  - PROFIBUS DP
  - Modbus RS485
  - EtherNet/IP
  - PROFINET
- Via service interface  
 CDI-RJ45 service interface

<b>Plain text display</b>	With information on cause and remedial measures
---------------------------	---

**Web browser**

<b>Plain text display</b>	With information on cause and remedial measures
---------------------------	---

**Light emitting diodes (LED)**

<b>Status information</b>	Status indicated by various light emitting diodes  The following information is displayed depending on the device version: <ul style="list-style-type: none"> <li>▪ Supply voltage active</li> <li>▪ Data transmission active</li> <li>▪ Device alarm/error has occurred</li> <li>▪ EtherNet/IP network available</li> <li>▪ EtherNet/IP connection established</li> <li>▪ PROFINET network available</li> <li>▪ PROFINET connection established</li> <li>▪ PROFINET blinking feature</li> </ul>
---------------------------	--

**Ex connection data**

These values only apply for the following device version:  
 Order code for "Output", option M "Modbus RS485", for use in intrinsically safe areas

**Safety Barrier Promass 100**

*Safety-related values*

Terminal numbers			
Supply voltage		Signal transmission	
2 (L-)	1 (L+)	26 (B)	27 (A)
$U_{nom} = DC\ 24\ V$ $U_{max} = AC\ 260\ V$		$U_{nom} = DC\ 5\ V$ $U_{max} = AC\ 260\ V$	

*Intrinsically safe values*

Terminal numbers			
Supply voltage		Signal transmission	
20 (L-)	10 (L+)	62 (B)	72 (A)
$U_o = 16.24 \text{ V}$ $I_o = 623 \text{ mA}$ $P_o = 2.45 \text{ W}$ With IIC: $L_o = 92.8 \text{ } \mu\text{H}$ , $C_o = 0.433 \text{ } \mu\text{F}$ , $L_o/R_o = 14.6 \text{ } \mu\text{H}/\Omega$			
 For an overview and for information on the interdependencies between the gas group - sensor - nominal diameter, see the "Safety Instructions" (XA) document for the measuring device			

**Transmitter***Intrinsically safe values*

Order code for "Approval"	Terminal numbers			
	Supply voltage		Signal transmission	
	20 (L-)	10 (L+)	62 (A)	72 (B)
<ul style="list-style-type: none"> <li>▪ Option <b>BM</b>: ATEX II2G + IECEx Z1 Ex ia, II2D Ex tb</li> <li>▪ Option <b>BO</b>: ATEX II1/2G + IECEx Z0/Z1 Ex ia, II2D</li> <li>▪ Option <b>BQ</b>: ATEX II1/2G + IECEx Z0/Z1 Ex ia</li> <li>▪ Option <b>BU</b>: ATEX II2G + IECEx Z1 Ex ia</li> <li>▪ Option <b>C2</b>: CSA C/US IS Cl. I, II, III Div. 1</li> <li>▪ Option <b>85</b>: ATEX II2G + IECEx Z1 Ex ia + CSA C/US IS Cl. I, II, III Div. 1</li> </ul>	$U_i = 16.24 \text{ V}$ $I_i = 623 \text{ mA}$ $P_i = 2.45 \text{ W}$ $L_i = 0 \text{ } \mu\text{H}$ $C_i = 6 \text{ nF}$			
 For an overview and for information on the interdependencies between the gas group - sensor - nominal diameter, see the "Safety Instructions" (XA) document for the measuring device				

**Low flow cut off**

The switch points for low flow cut off are user-selectable.

**Protocol-specific data****HART**

Manufacturer ID	0x11
Device type ID	0x4A
HART protocol revision	7
Device description files (DTM, DD)	Information and files under: <a href="http://www.endress.com">www.endress.com</a>
HART load	Min. 250 $\Omega$

<p><b>Dynamic variables</b></p>	<p>Read out the dynamic variables: HART command 3 The measured variables can be freely assigned to the dynamic variables.</p> <p><b>Measured variables for PV (primary dynamic variable)</b></p> <ul style="list-style-type: none"> <li>▪ Mass flow</li> <li>▪ Volume flow</li> <li>▪ Corrected volume flow</li> <li>▪ Density</li> <li>▪ Reference density</li> <li>▪ Temperature</li> </ul> <p><b>Measured variables for SV, TV, QV (secondary, tertiary and quaternary dynamic variable)</b></p> <ul style="list-style-type: none"> <li>▪ Mass flow</li> <li>▪ Volume flow</li> <li>▪ Corrected volume flow</li> <li>▪ Density</li> <li>▪ Reference density</li> <li>▪ Temperature</li> <li>▪ Totalizer 1</li> <li>▪ Totalizer 2</li> <li>▪ Totalizer 3</li> </ul> <p> The range of options increases if the measuring device has one or more application packages.</p> <p><b>Heartbeat Technology application package</b> Additional measured variables are available with the Heartbeat Technology application package:</p> <ul style="list-style-type: none"> <li>▪ Carrier pipe temperature</li> <li>▪ Oscillation amplitude 0</li> </ul>
<p><b>Device variables</b></p>	<p>Read out the device variables: HART command 9 The device variables are permanently assigned.</p> <p>A maximum of 8 device variables can be transmitted:</p> <ul style="list-style-type: none"> <li>▪ 0 = mass flow</li> <li>▪ 1 = volume flow</li> <li>▪ 2 = corrected volume flow</li> <li>▪ 3 = density</li> <li>▪ 4 = reference density</li> <li>▪ 5 = temperature</li> <li>▪ 6 = totalizer 1</li> <li>▪ 7 = totalizer 2</li> <li>▪ 8 = totalizer 3</li> <li>▪ 13 = target mass flow</li> <li>▪ 14 = carrier mass flow</li> <li>▪ 15 = concentration</li> </ul>

**PROFIBUS DP**

<p><b>Manufacturer ID</b></p>	<p>0x11</p>
<p><b>Ident number</b></p>	<p>0x1561</p>
<p><b>Profile version</b></p>	<p>3.02</p>
<p><b>Device description files (GSD, DTM, DD)</b></p>	<p>Information and files under:</p> <ul style="list-style-type: none"> <li>▪ <a href="http://www.endress.com">www.endress.com</a></li> <li>▪ On the product page for the device: Documents/Software → Device drivers</li> <li>▪ <a href="http://www.profibus.org">www.profibus.org</a></li> </ul>

<b>Output values</b> (from measuring device to automation system)	<b>Analog input 1 to 8</b> <ul style="list-style-type: none"> <li>▪ Mass flow</li> <li>▪ Volume flow</li> <li>▪ Corrected volume flow</li> <li>▪ Target mass flow</li> <li>▪ Carrier mass flow</li> <li>▪ Density</li> <li>▪ Reference density</li> <li>▪ Concentration</li> <li>▪ Temperature</li> <li>▪ Carrier pipe temperature</li> <li>▪ Electronic temperature</li> <li>▪ Oscillation frequency</li> <li>▪ Oscillation amplitude</li> <li>▪ Frequency fluctuation</li> <li>▪ Oscillation damping</li> <li>▪ Tube damping fluctuation</li> <li>▪ Signal asymmetry</li> <li>▪ Exciter current</li> </ul> <b>Digital input 1 to 2</b> <ul style="list-style-type: none"> <li>▪ Partially filled pipe detection</li> <li>▪ Low flow cut off</li> </ul> <b>Totalizer 1 to 3</b> <ul style="list-style-type: none"> <li>▪ Mass flow</li> <li>▪ Volume flow</li> <li>▪ Corrected volume flow</li> </ul>
<b>Input values</b> (from automation system to measuring device)	<b>Analog output 1 to 3 (fixed assignment)</b> <ul style="list-style-type: none"> <li>▪ Pressure</li> <li>▪ Temperature</li> <li>▪ Reference density</li> </ul> <b>Digital output 1 to 3 (fixed assignment)</b> <ul style="list-style-type: none"> <li>▪ Digital output 1: switch positive zero return on/off</li> <li>▪ Digital output 2: perform zero point adjustment</li> <li>▪ Digital output 3: switch switch output on/off</li> </ul> <b>Totalizer 1 to 3</b> <ul style="list-style-type: none"> <li>▪ Totalize</li> <li>▪ Reset and hold</li> <li>▪ Preset and hold</li> <li>▪ Stop</li> <li>▪ Operating mode configuration:             <ul style="list-style-type: none"> <li>▪ Net flow total</li> <li>▪ Forward flow total</li> <li>▪ Reverse flow total</li> </ul> </li> </ul>
<b>Supported functions</b>	<ul style="list-style-type: none"> <li>▪ Identification &amp; Maintenance Simplest device identification on the part of the control system and nameplate</li> <li>▪ PROFIBUS upload/download Reading and writing parameters is up to ten times faster with PROFIBUS upload/download</li> <li>▪ Condensed status Simplest and self-explanatory diagnostic information by categorizing diagnostic messages that occur</li> </ul>
<b>Configuration of the device address</b>	<ul style="list-style-type: none"> <li>▪ DIP switches on the I/O electronics module</li> <li>▪ Via operating tools (e.g. FieldCare)</li> </ul>

### Modbus RS485

Protocol	Modbus Applications Protocol Specification V1.1
Device type	Slave
Slave address range	1 to 247
Broadcast address range	0

<b>Function codes</b>	<ul style="list-style-type: none"> <li>▪ 03: Read holding register</li> <li>▪ 04: Read input register</li> <li>▪ 06: Write single registers</li> <li>▪ 08: Diagnostics</li> <li>▪ 16: Write multiple registers</li> <li>▪ 23: Read/write multiple registers</li> </ul>
<b>Broadcast messages</b>	<p>Supported by the following function codes:</p> <ul style="list-style-type: none"> <li>▪ 06: Write single registers</li> <li>▪ 16: Write multiple registers</li> <li>▪ 23: Read/write multiple registers</li> </ul>
<b>Supported baud rate</b>	<ul style="list-style-type: none"> <li>▪ 1 200 BAUD</li> <li>▪ 2 400 BAUD</li> <li>▪ 4 800 BAUD</li> <li>▪ 9 600 BAUD</li> <li>▪ 19 200 BAUD</li> <li>▪ 38 400 BAUD</li> <li>▪ 57 600 BAUD</li> <li>▪ 115 200 BAUD</li> </ul>
<b>Data transfer mode</b>	<ul style="list-style-type: none"> <li>▪ ASCII</li> <li>▪ RTU</li> </ul>
<b>Data access</b>	<p>Each device parameter can be accessed via Modbus RS485.</p> <p> For Modbus register information, see "Description of device parameters" documentation</p>

#### EtherNet/IP

<b>Protocol</b>	<ul style="list-style-type: none"> <li>▪ The CIP Networks Library Volume 1: Common Industrial Protocol</li> <li>▪ The CIP Networks Library Volume 2: EtherNet/IP Adaptation of CIP</li> </ul>
<b>Communication type</b>	<ul style="list-style-type: none"> <li>▪ 10Base-T</li> <li>▪ 100Base-TX</li> </ul>
<b>Device profile</b>	Generic device (product type: 0x2B)
<b>Manufacturer ID</b>	0x49E
<b>Device type ID</b>	0x104A
<b>Baud rates</b>	Automatic <sup>10</sup> / <sub>100</sub> Mbit with half-duplex and full-duplex detection
<b>Polarity</b>	Auto-polarity for automatic correction of crossed TxD and RxD pairs
<b>Supported CIP connections</b>	Max. 3 connections
<b>Explicit connections</b>	Max. 6 connections
<b>I/O connections</b>	Max. 6 connections (scanner)
<b>Configuration options for measuring device</b>	<ul style="list-style-type: none"> <li>▪ DIP switches on the electronics module for IP addressing</li> <li>▪ Manufacturer-specific software (FieldCare)</li> <li>▪ Add-on Profile Level 3 for Rockwell Automation control systems</li> <li>▪ Web browser</li> <li>▪ Electronic Data Sheet (EDS) integrated in the measuring device</li> </ul>
<b>Configuration of the EtherNet interface</b>	<ul style="list-style-type: none"> <li>▪ Speed: 10 MBit, 100 MBit, auto (factory setting)</li> <li>▪ Duplex: half-duplex, full-duplex, auto (factory setting)</li> </ul>
<b>Configuration of the device address</b>	<ul style="list-style-type: none"> <li>▪ DIP switches on the electronics module for IP addressing (last octet)</li> <li>▪ DHCP</li> <li>▪ Manufacturer-specific software (FieldCare)</li> <li>▪ Add-on Profile Level 3 for Rockwell Automation control systems</li> <li>▪ Web browser</li> <li>▪ EtherNet/IP tools, e.g. RSLinx (Rockwell Automation)</li> </ul>
<b>Device Level Ring (DLR)</b>	No

<b>Fix Input</b>			
<b>RPI</b>	5 ms to 10 s (factory setting: 20 ms)		
<b>Exclusive Owner Multicast</b>		<b>Instance</b>	<b>Size [byte]</b>
	Instance configuration:	0x68	398
	O → T configuration:	0x66	64
	T → O configuration:	0x64	44
<b>Exclusive Owner Multicast</b>		<b>Instance</b>	<b>Size [byte]</b>
	Instance configuration:	0x69	-
	O → T configuration:	0x66	64
	T → O configuration:	0x64	44
<b>Input only Multicast</b>		<b>Instance</b>	<b>Size [byte]</b>
	Instance configuration:	0x68	398
	O → T configuration:	0xC7	-
	T → O configuration:	0x64	44
<b>Input only Multicast</b>		<b>Instance</b>	<b>Size [byte]</b>
	Instance configuration:	0x69	-
	O → T configuration:	0xC7	-
	T → O configuration:	0x64	44
<b>Input Assembly</b>	<ul style="list-style-type: none"> <li>▪ Current device diagnostics</li> <li>▪ Mass flow</li> <li>▪ Volume flow</li> <li>▪ Corrected volume flow</li> <li>▪ Density</li> <li>▪ Reference density</li> <li>▪ Temperature</li> <li>▪ Totalizer 1</li> <li>▪ Totalizer 2</li> <li>▪ Totalizer 3</li> </ul>		
<b>Configurable Input</b>			
<b>RPI</b>	5 ms to 10 s (factory setting: 20 ms)		
<b>Exclusive Owner Multicast</b>		<b>Instance</b>	<b>Size [byte]</b>
	Instance configuration:	0x68	398
	O → T configuration:	0x66	64
	T → O configuration:	0x65	88
<b>Exclusive Owner Multicast</b>		<b>Instance</b>	<b>Size [byte]</b>
	Instance configuration:	0x69	-
	O → T configuration:	0x66	64
	T → O configuration:	0x65	88
<b>Input only Multicast</b>		<b>Instance</b>	<b>Size [byte]</b>
	Instance configuration:	0x68	398
	O → T configuration:	0xC7	-
	T → O configuration:	0x65	88
<b>Input only Multicast</b>		<b>Instance</b>	<b>Size [byte]</b>
	Instance configuration:	0x69	-
	O → T configuration:	0xC7	-
	T → O configuration:	0x65	88



<b>Configurable Input Assembly</b>	<ul style="list-style-type: none"> <li>■ Current device diagnostics</li> <li>■ Mass flow</li> <li>■ Volume flow</li> <li>■ Corrected volume flow</li> <li>■ Density</li> <li>■ Reference density</li> <li>■ Temperature</li> <li>■ Totalizer 1</li> <li>■ Totalizer 2</li> <li>■ Totalizer 3</li> </ul> <p> The range of options increases if the measuring device has one or more application packages.</p>
<b>Fix Output</b>	
<b>Output Assembly</b>	<ul style="list-style-type: none"> <li>■ Activation of reset totalizers 1-3</li> <li>■ Activation of pressure compensation</li> <li>■ Activation of reference density compensation</li> <li>■ Activation of temperature compensation</li> <li>■ Reset totalizers 1-3</li> <li>■ External pressure value</li> <li>■ Pressure unit</li> <li>■ External reference density</li> <li>■ Reference density unit</li> <li>■ External temperature</li> <li>■ Temperature unit</li> </ul>
<b>Configuration</b>	
<b>Configuration Assembly</b>	<p>Only the most common configurations are listed below.</p> <ul style="list-style-type: none"> <li>■ Software write protection</li> <li>■ Mass flow unit</li> <li>■ Mass unit</li> <li>■ Volume flow unit</li> <li>■ Volume unit</li> <li>■ Corrected volume flow unit</li> <li>■ Corrected volume unit</li> <li>■ Density unit</li> <li>■ Reference density unit</li> <li>■ Temperature unit</li> <li>■ Pressure unit</li> <li>■ Length</li> <li>■ Totalizer 1-3:                             <ul style="list-style-type: none"> <li>■ Assignment</li> <li>■ Unit</li> <li>■ Operating mode</li> <li>■ Failsafe mode</li> </ul> </li> <li>■ Alarm delay</li> </ul>

**PROFINET**

<b>Protocol</b>	"Application layer protocol for decentral device periphery and distributed automation", version 2.3
<b>Conformity class</b>	B
<b>Communication type</b>	100 MBit/s
<b>Device profile</b>	Application interface identifier 0xF600 Generic device
<b>Manufacturer ID</b>	0x11
<b>Device type ID</b>	0x844A
<b>Device description files (GSD, DTM)</b>	Information and files under: <ul style="list-style-type: none"> <li>■ <a href="http://www.endress.com">www.endress.com</a> On the product page for the device: Documents/Software → Device drivers</li> <li>■ <a href="http://www.profibus.org">www.profibus.org</a></li> </ul>
<b>Baud rates</b>	Automatic 100 Mbit/s with full-duplex detection

<b>Cycle times</b>	From 8 ms
<b>Polarity</b>	Auto-polarity for automatic correction of crossed TxD and RxD pairs
<b>Supported connections</b>	<ul style="list-style-type: none"> <li>▪ 1 x AR (Application Relation)</li> <li>▪ 1 x Input CR (Communication Relation)</li> <li>▪ 1 x Output CR (Communication Relation)</li> <li>▪ 1 x Alarm CR (Communication Relation)</li> </ul>
<b>Configuration options for measuring device</b>	<ul style="list-style-type: none"> <li>▪ DIP switches on the electronics module, for device name assignment (last part)</li> <li>▪ Manufacturer-specific software (FieldCare, DeviceCare)</li> <li>▪ Web browser</li> <li>▪ Device master file (GSD), can be read out via the integrated Web server of the measuring device</li> </ul>
<b>Configuration of the device name</b>	<ul style="list-style-type: none"> <li>▪ DIP switches on the electronics module, for device name assignment (last part)</li> <li>▪ DCP protocol</li> </ul>
<b>Output values</b> (from measuring device to automation system)	<p><b>Analog Input module (slot 1 to 14)</b></p> <ul style="list-style-type: none"> <li>▪ Mass flow</li> <li>▪ Volume flow</li> <li>▪ Corrected volume flow</li> <li>▪ Target mass flow</li> <li>▪ Carrier mass flow</li> <li>▪ Density</li> <li>▪ Reference density</li> <li>▪ Concentration</li> <li>▪ Temperature</li> <li>▪ Carrier pipe temperature</li> <li>▪ Electronic temperature</li> <li>▪ Oscillation frequency</li> <li>▪ Oscillation amplitude</li> <li>▪ Frequency fluctuation</li> <li>▪ Oscillation damping</li> <li>▪ Tube damping fluctuation</li> <li>▪ Signal asymmetry</li> <li>▪ Exciter current</li> </ul> <p><b>Discrete Input module (slot 1 to 14)</b></p> <ul style="list-style-type: none"> <li>▪ Empty pipe detection</li> <li>▪ Low flow cut off</li> </ul> <p><b>Diagnostics Input module (slot 1 to 14)</b></p> <ul style="list-style-type: none"> <li>▪ Last diagnostics</li> <li>▪ Current diagnosis</li> </ul> <p><b>Totalizer 1 to 3 (slot 15 to 17)</b></p> <ul style="list-style-type: none"> <li>▪ Mass flow</li> <li>▪ Volume flow</li> <li>▪ Corrected volume flow</li> </ul> <p><b>Heartbeat Verification module (fixed assignment)</b> Verification status (slot 23)</p> <p> The range of options increases if the measuring device has one or more application packages.</p>

<p><b>Input values</b> (from automation system to measuring device)</p>	<p><b>Analog Output module (fixed assignment)</b></p> <ul style="list-style-type: none"> <li>▪ External pressure (slot 18)</li> <li>▪ External temperature (slot 19)</li> <li>▪ External reference density (slot 20)</li> </ul> <p><b>Discrete Output module (fixed assignment)</b></p> <ul style="list-style-type: none"> <li>▪ Activate/deactivate positive zero return (slot 21)</li> <li>▪ Perform zero point adjustment (slot 22)</li> </ul> <p><b>Totalizer 1 to 3 (slot 15 to 17)</b></p> <ul style="list-style-type: none"> <li>▪ Totalize</li> <li>▪ Reset and hold</li> <li>▪ Preset and hold</li> <li>▪ Stop</li> <li>▪ Operating mode configuration:                         <ul style="list-style-type: none"> <li>▪ Net flow total</li> <li>▪ Forward flow total</li> <li>▪ Reverse flow total</li> </ul> </li> </ul> <p><b>Heartbeat Verification module (fixed assignment)</b> Start verification (slot 23)</p> <p> The range of options increases if the measuring device has one or more application packages.</p>
<p><b>Supported functions</b></p>	<ul style="list-style-type: none"> <li>▪ Identification &amp; Maintenance Simple device identification via:                         <ul style="list-style-type: none"> <li>▪ Control system</li> <li>▪ Nameplate</li> </ul> </li> <li>▪ Measured value status The process variables are communicated with a measured value status</li> <li>▪ Blinking feature via the local display for simple device identification and assignment</li> </ul>

*Administration of software options*

Input/output value	Process variable	Category	Slot
Output value	Mass flow	Process variable	1 to 14
	Volume flow		
	Corrected volume flow		
	Density		
	Reference density		
	Temperature		
	Electronic temperature		
	Oscillation frequency		
	Frequency fluctuation		
	Oscillation damping		
	Oscillation frequency		
	Signal asymmetry		
	Exciter current		
	Empty pipe detection		
	Low flow cut off		
Output value	Target mass flow	Concentration <sup>1)</sup>	1 to 14
Output value	Carrier mass flow		
Output value	Concentration		
Output value	Carrier pipe temperature	Heartbeat <sup>2)</sup>	1 to 14

Input/output value	Process variable	Category	Slot
	Oscillation damping 1		
	Oscillation frequency 1		
	Oscillation amplitude 0		
	Oscillation amplitude 1		
	Frequency fluctuation 1		
	Tube damping fluctuation 1		
	Exciter current 1		
Input value	External density	Process monitoring	18
	External temperature		19
	External reference density		20
	Flow override		21
	Zero point adjustment		22
	Status verification	Heartbeat Verification <sup>2)</sup>	23

1) Only available with the "Concentration" application package.

2) Only available with the "Heartbeat" application package.

*Startup configuration*

<p>Startup configuration (NSU)</p>	<p>If startup configuration is enabled, the configuration of the most important device parameters is taken from the automation system and used.</p> <p>The following configuration is taken from the automation system:</p> <ul style="list-style-type: none"> <li>▪ Management             <ul style="list-style-type: none"> <li>▪ Software revision</li> <li>▪ Write protection</li> </ul> </li> <li>▪ System units             <ul style="list-style-type: none"> <li>▪ Mass flow</li> <li>▪ Mass</li> <li>▪ Volume flow</li> <li>▪ Volume</li> <li>▪ Corrected volume flow</li> <li>▪ Corrected volume</li> <li>▪ Density</li> <li>▪ Reference density</li> <li>▪ Temperature</li> <li>▪ Pressure</li> </ul> </li> <li>▪ Concentration application package             <ul style="list-style-type: none"> <li>▪ Coefficients A0 to A4</li> <li>▪ Coefficients B1 to B3</li> </ul> </li> <li>▪ Sensor adjustment</li> <li>▪ Process parameter             <ul style="list-style-type: none"> <li>▪ Damping (flow, density, temperature)</li> <li>▪ Flow override</li> </ul> </li> <li>▪ Low flow cut off             <ul style="list-style-type: none"> <li>▪ Assign process variable</li> <li>▪ Switch-on/switch-off point</li> <li>▪ Pressure shock suppression</li> </ul> </li> <li>▪ Empty pipe detection             <ul style="list-style-type: none"> <li>▪ Assign process variable</li> <li>▪ Limit values</li> <li>▪ Response time</li> <li>▪ Max. damping</li> </ul> </li> <li>▪ Corrected volume flow calculation             <ul style="list-style-type: none"> <li>▪ External reference density</li> <li>▪ Fixed reference density</li> <li>▪ Reference temperature</li> <li>▪ Linear expansion coefficient</li> <li>▪ Square expansion coefficient</li> </ul> </li> <li>▪ Measuring mode             <ul style="list-style-type: none"> <li>▪ Medium</li> <li>▪ Gas type</li> <li>▪ Reference sound velocity</li> <li>▪ Temperature coefficient sound velocity</li> </ul> </li> <li>▪ External compensation             <ul style="list-style-type: none"> <li>▪ Pressure compensation</li> <li>▪ Pressure value</li> <li>▪ External pressure</li> </ul> </li> <li>▪ Diagnostic settings</li> <li>▪ Diagnostic behavior for diverse diagnostic information</li> </ul>
------------------------------------	---

## Power supply

### Terminal assignment

### Overview: housing version and connection versions

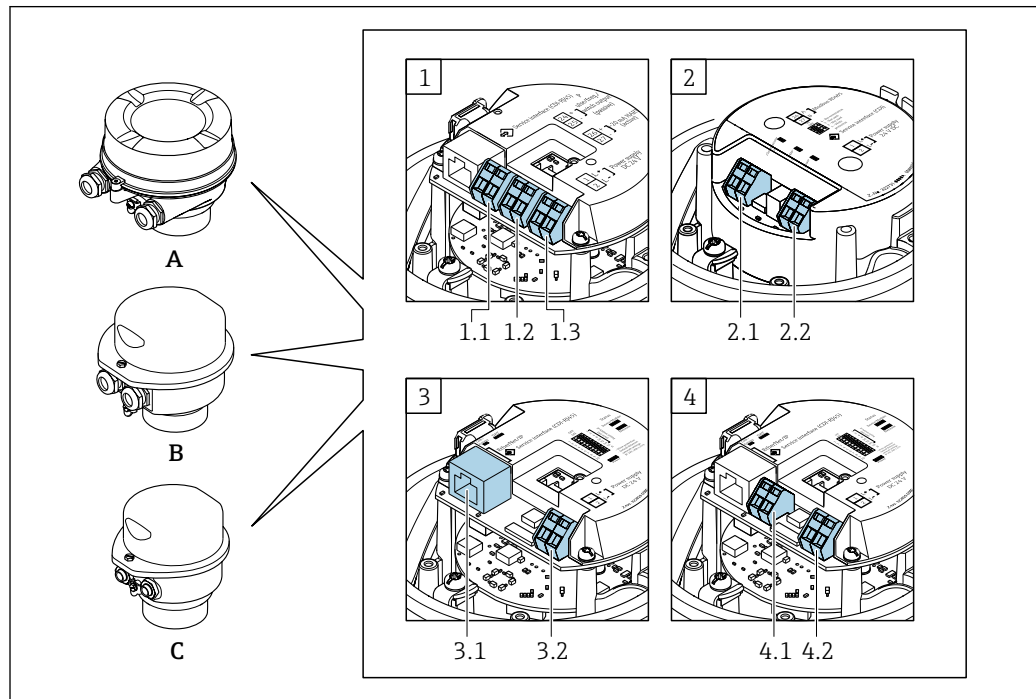

A0016770

- A Housing version: compact, aluminum coated
- B Housing version: compact, hygienic, stainless
- C Housing version: ultra-compact, hygienic, stainless
- 1 Connection version: 4-20 mA HART, pulse/frequency/switch output
- 1.1 Signal transmission: pulse/frequency/switch output
- 1.2 Signal transmission: 4-20 mA HART
- 1.3 Supply voltage
- 2 Connection version: Modbus RS485
- 2.1 Signal transmission
- 2.2 Supply voltage
- 3 Connection versions: EtherNet/IP and PROFINET
- 3.1 Signal transmission
- 3.2 Supply voltage
- 4 Connection version: PROFIBUS DP
- 4.1 Signal transmission
- 4.2 Supply voltage

### Transmitter

Connection version 4-20 mA HART with pulse/frequency/switch output

Order code for "Output", option **B**

Depending on the housing version, the transmitters can be ordered with terminals or device plugs.

Order code "Housing"	Connection methods available		Possible options for order code "Electrical connection"
	Outputs	Power supply	
Options A, B	Terminals	Terminals	<ul style="list-style-type: none"> <li>▪ Option A: coupling M20x1</li> <li>▪ Option B: thread M20x1</li> <li>▪ Option C: thread G ½"</li> <li>▪ Option D: thread NPT ½"</li> </ul>
Options A, B	Device plugs → 30	Terminals	<ul style="list-style-type: none"> <li>▪ Option L: plug M12x1 + thread NPT ½"</li> <li>▪ Option N: plug M12x1 + coupling M20</li> <li>▪ Option P: plug M12x1 + thread G ½"</li> <li>▪ Option U: plug M12x1 + thread M20</li> </ul>
Options A, B, C	Device plugs → 30	Device plugs → 30	Option Q: 2 x plug M12x1

Order code for "Housing":

- Option A: compact, coated aluminum
- Option B: compact, hygienic, stainless
- Option C: ultra-compact, hygienic, stainless

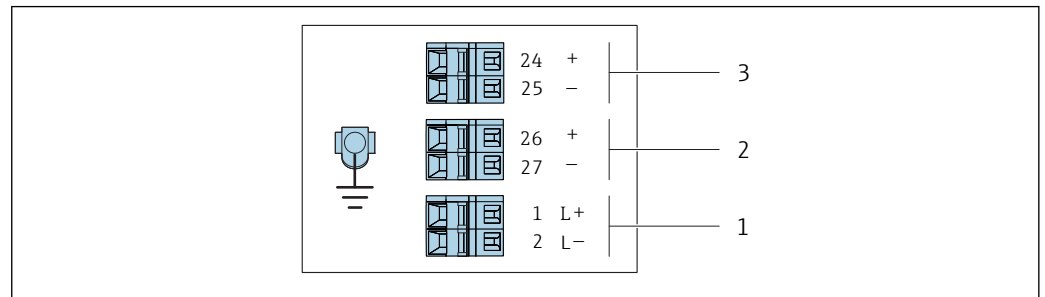

A0016888

2 Terminal assignment 4-20 mA HART with pulse/frequency/switch output

- 1 Power supply: DC 24 V
- 2 Output 1: 4-20 mA HART (active)
- 3 Output 2: pulse/frequency/switch output (passive)

Order code "Output"	Terminal number					
	Power supply		Output 1		Output 2	
	2 (L-)	1 (L+)	27 (-)	26 (+)	25 (-)	24 (+)
Option B	DC 24 V		4-20 mA HART (active)		Pulse/frequency/switch output (passive)	

Order code for "Output":



Option B: 4-20 mA HART with pulse/frequency/switch output

*PROFIBUS DP connection version*

 For use in the non-hazardous area and Zone 2/Div. 2

Order code for "Output", option **L**

Depending on the housing version, the transmitters can be ordered with terminals or device plugs.

Order code "Housing"	Connection methods available		Possible options for order code "Electrical connection"
	Output	Power supply	
Options A, B	Terminals	Terminals	<ul style="list-style-type: none"> <li>▪ Option A: coupling M20x1</li> <li>▪ Option B: thread M20x1</li> <li>▪ Option C: thread G ½"</li> <li>▪ Option D: thread NPT ½"</li> </ul>
Options A, B	Device plug connectors →  30	Terminals	<ul style="list-style-type: none"> <li>▪ Option L: plug M12x1 + thread NPT ½"</li> <li>▪ Option N: plug M12x1 + coupling M20</li> <li>▪ Option P: plug M12x1 + thread G ½"</li> <li>▪ Option U: plug M12x1 + thread M20</li> </ul>
Options A, B, C	Device plug connectors →  30	Device plug connectors →  30	Option Q: 2 x plug M12x1
Order code for "Housing": <ul style="list-style-type: none"> <li>▪ Option A: compact, coated aluminum</li> <li>▪ Option B: compact, hygienic, stainless</li> <li>▪ Option C ultra-compact, hygienic, stainless</li> </ul>			

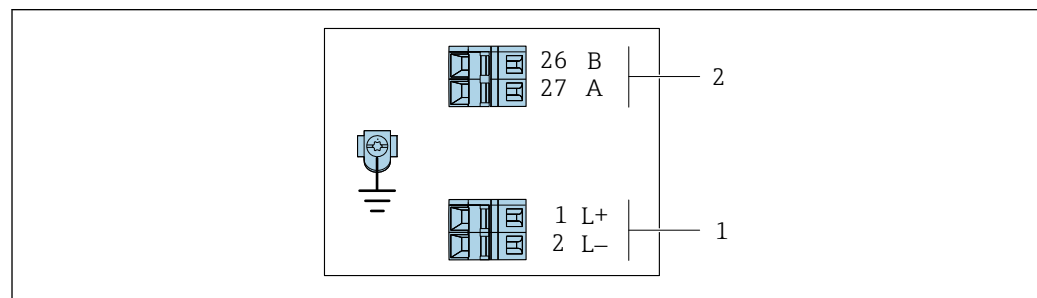

A0022716

 3 PROFIBUS DP terminal assignment

- 1 Power supply: DC 24 V
- 2 PROFIBUS DP

Order code "Output"	Terminal number			
	Power supply		Output	
	2 (L-)	1 (L+)	26 (RxD/TxD-P)	27 (RxD/TxD-N)
Option L	DC 24 V		B	A
Order code for "Output": Option L: PROFIBUS DP, for use in non-hazardous areas and Zone 2/Div. 2				





Modbus RS485 connection version

 For use in the non-hazardous area and Zone 2/Div. 2

Order code for "Output", option **M**

Depending on the housing version, the transmitters can be ordered with terminals or device plugs.

Order code "Housing"	Connection methods available		Possible options for order code "Electrical connection"
	Output	Power supply	
Options A, B	Terminals	Terminals	<ul style="list-style-type: none"> <li>▪ Option A: coupling M20x1</li> <li>▪ Option B: thread M20x1</li> <li>▪ Option C: thread G ½"</li> <li>▪ Option D: thread NPT ½"</li> </ul>
Options A, B	Device plugs →  30	Terminals	<ul style="list-style-type: none"> <li>▪ Option L: plug M12x1 + thread NPT ½"</li> <li>▪ Option N: plug M12x1 + coupling M20</li> <li>▪ Option P: plug M12x1 + thread G ½"</li> <li>▪ Option U: plug M12x1 + thread M20</li> </ul>
Options A, B, C	Device plugs →  30	Device plugs →  30	Option Q: 2 x plug M12x1
Order code for "Housing": <ul style="list-style-type: none"> <li>▪ Option A: compact, coated aluminum</li> <li>▪ Option B: compact, hygienic, stainless</li> <li>▪ Option C: ultra-compact, hygienic, stainless</li> </ul>			

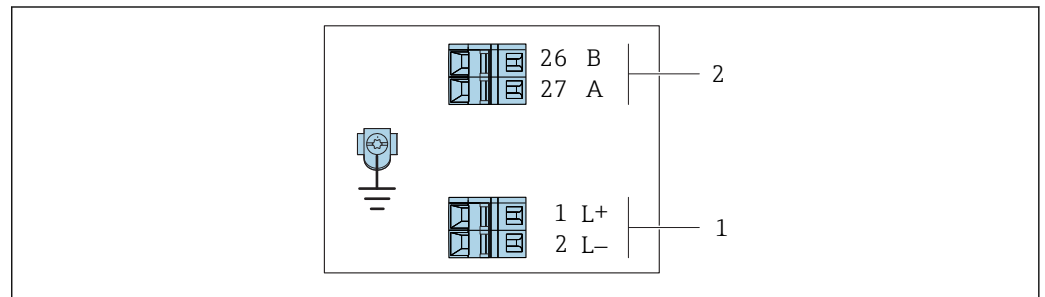

 4 Modbus RS485 terminal assignment, connection version for use in non-hazardous areas and Zone 2/Div. 2

- 1 Power supply: DC 24 V
- 2 Modbus RS485

Order code "Output"	Terminal number			
	Power supply		Output	
	1 (L+)	2 (L-)	26 (B)	27 (A)
Option M	DC 24 V		Modbus RS485	
Order code for "Output": Option <b>M</b> : Modbus RS485, for use in non-hazardous areas and Zone 2/Div. 2				

Modbus RS485 connection version

 For use in the intrinsically safe area. Connection via Safety Barrier Promass 100.

Order code for "Output", option **M**

Depending on the housing version, the transmitters can be ordered with terminals or device plugs.

Order code "Housing"	Connection methods available		Possible options for order code "Electrical connection"
	Output	Power supply	
Options A, B	Terminals	Terminals	<ul style="list-style-type: none"> <li>▪ Option A: coupling M20x1</li> <li>▪ Option B: thread M20x1</li> <li>▪ Option C: thread G ½"</li> <li>▪ Option D: thread NPT ½"</li> </ul>
A, B, C	Device plugs →  30		Option I: plug M12x1
Order code for "Housing": <ul style="list-style-type: none"> <li>▪ Option A: compact, coated aluminum</li> <li>▪ Option B: compact, hygienic, stainless</li> <li>▪ Option C: ultra-compact, hygienic, stainless</li> </ul>			

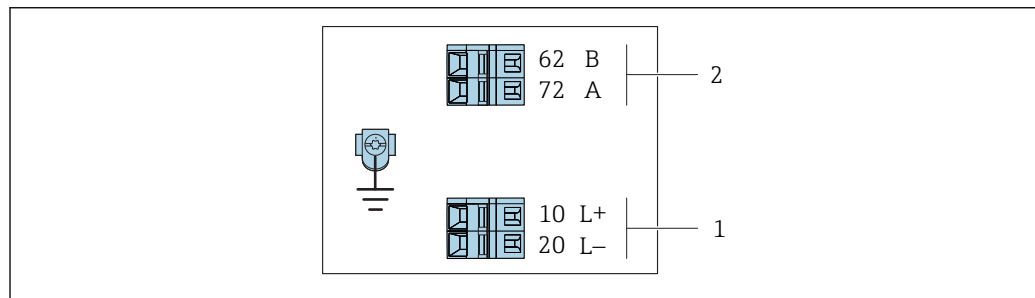

A0030219

 5 Modbus RS485 terminal assignment, connection version for use in intrinsically safe areas (connection via Safety Barrier Promass 100)



- 1 Intrinsically safe power supply
- 2 Modbus RS485

Order code "Output"	10 (L+)	20 (L-)	62 (B)	72 (A)
Option <b>M</b>	Intrinsically safe supply voltage		Modbus RS485 intrinsically safe	
Order code for "Output": Option <b>M</b> : Modbus RS485, for use in the intrinsically safe area (connection via Safety Barrier Promass 100)				

*EtherNet/IP connection version*

Order code for "Output", option **N**

Depending on the housing version, the transmitters can be ordered with terminals or device plugs.

Order code "Housing"	Connection methods available		Possible options for order code "Electrical connection"
	Output	Power supply	
Options <b>A, B</b>	Device plug connectors →  31	Terminals	<ul style="list-style-type: none"> <li>▪ Option <b>L</b>: plug M12x1 + thread NPT 1/2"</li> <li>▪ Option <b>N</b>: plug M12x1 + coupling M20</li> <li>▪ Option <b>P</b>: plug M12x1 + thread G 1/2"</li> <li>▪ Option <b>U</b>: plug M12x1 + thread M20</li> </ul>
Options <b>A, B, C</b>	Device plug connectors →  31	Device plug connectors →  31	Option <b>Q</b> : 2 x plug M12x1
Order code for "Housing": <ul style="list-style-type: none"> <li>▪ Option <b>A</b>: compact, coated aluminum</li> <li>▪ Option <b>B</b>: compact, hygienic, stainless</li> <li>▪ Option <b>C</b>: ultra-compact, hygienic, stainless</li> </ul>			

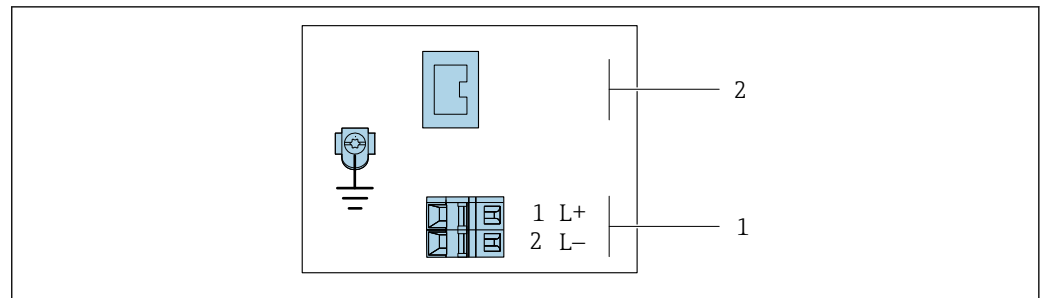

A0017054

 6 *EtherNet/IP terminal assignment*

- 1 Power supply: DC 24 V
- 2 EtherNet/IP

Order code "Output"	Terminal number		Output Device plug M12x1
	Power supply 2 (L-)	1 (L+)	
Option <b>N</b>	DC 24 V		EtherNet/IP
Order code for "Output": Option <b>N</b> : EtherNet/IP			

*PROFINET connection version*

Order code for "Output", option **R**

Depending on the housing version, the transmitters can be ordered with terminals or device plugs.

Order code "Housing"	Connection methods available		Possible options for order code "Electrical connection"
	Output	Power supply	
Options <b>A, B</b>	Device plug connectors → 29	Terminals	<ul style="list-style-type: none"> <li>▪ Option <b>L</b>: plug M12x1 + thread NPT ½"</li> <li>▪ Option <b>N</b>: plug M12x1 + coupling M20</li> <li>▪ Option <b>P</b>: plug M12x1 + thread G ½"</li> <li>▪ Option <b>U</b>: plug M12x1 + thread M20</li> </ul>
Options <b>A, B, C</b>	Device plug connectors → 29	Device plug connectors → 29	Option <b>Q</b> : 2 x plug M12x1
Order code for "Housing": <ul style="list-style-type: none"> <li>▪ Option <b>A</b>: compact, coated aluminum</li> <li>▪ Option <b>B</b>: compact, hygienic, stainless</li> <li>▪ Option <b>C</b> ultra-compact, hygienic, stainless</li> </ul>			

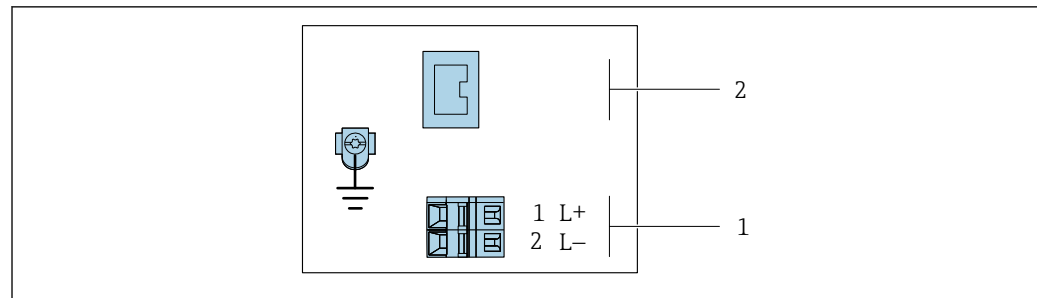

A0017054

**7** *PROFINET terminal assignment*

- 1 Power supply: DC 24 V
- 2 PROFINET

Order code "Output"	Terminal number		Output Device plug M12x1
	Power supply 2 (L-)	1 (L+)	
Option <b>R</b>	DC 24 V		PROFINET
Order code for "Output": Option <b>R</b> : PROFINET			

**Safety Barrier Promass 100**

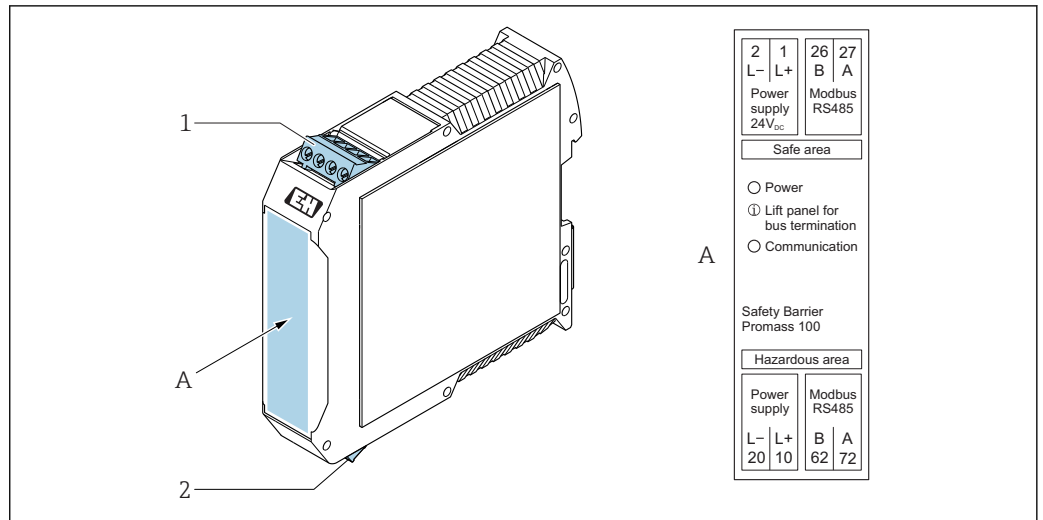

8 Safety Barrier Promass 100 with terminals

- 1 Non-hazardous area, Zone 2, Class I Division 2
- 2 Intrinsically safe area

A0030220

**Pin assignment, device plug**

- i** Order codes for the M12x1 connectors, see the "Order code for **electrical connection**" column:
  - 4-20 mA HART, pulse/frequency/switch output → 22
  - PROFIBUS DP → 24
  - Modbus RS485 → 25
  - EtherNet/IP → 27
  - PROFINET → 28

**Supply voltage**

For all connection versions except MODBUS RS485 intrinsically safe (device side)

- i** Device plug MODBUS RS485 intrinsically safe with supply voltage → 30

<p style="text-align: center; font-size: small;">A0029042</p>	Pin	Assignment	
	1	L+	DC 24 V
	2		Not assigned
	3		Not assigned
	4	L-	DC 24 V
	5		Grounding/shielding <sup>1)</sup>
Coding		Plug/socket	
A		Plug	

1) Not assigned for order code for "Housing", option C "Ultra-compact, hygienic, stainless"

- i** The following is recommended as a socket:
  - Binder, series 763, part no. 79 3440 35 05
  - Alternatively: Phoenix part no. 1682951 SAC-5P-5.0-PUR/M12FS SH
    - With the order code for "Output", option **B**: 4-20 mA HART, pulse/frequency/switch output
    - With the order code for "Output", option **N**: EtherNet/IP
  - When using the device in a hazardous location: Use a suitably certified socket.

### 4-20 mA HART with pulse/frequency/switch output

Device plug for signal transmission (device side)

	Pin	Assignment	
	1	+	4-20 mA HART (active)
	2	-	4-20 mA HART (active)
	3	+	Pulse/frequency/switch output (passive)
	4	-	Pulse/frequency/switch output (passive)
	5		Grounding/shielding <sup>1)</sup>
Coding		Plug/socket	
A		Socket	

1) Not assigned for order code for "Housing", option C "Ultra-compact, hygienic, stainless"

- Recommended plug: Binder, series 763, part no. 79 3439 12 05
- When using the device in a hazardous location, use a suitably certified plug.

### PROFIBUS DP

For use in the non-hazardous area and Zone 2/Div. 2.

Device plug for signal transmission (device side)

	Pin	Assignment	
	1		Not assigned
	2	A	PROFIBUS DP
	3		Not assigned
	4	B	PROFIBUS DP
	5		Grounding/shielding <sup>1)</sup>
Coding		Plug/socket	
B		Socket	

1) Not assigned for order code for "Housing", option C "Ultra-compact, hygienic, stainless"

- Recommended plug: Binder, series 763, part no. 79 4449 20 05
- When using the device in a hazardous location, use a suitably certified plug.

### MODBUS RS485

Device plug for signal transmission with supply voltage (device side), MODBUS RS485 (intrinsically safe)

	Pin	Assignment	
	1	L+	Supply voltage, intrinsically safe
	2	A	Modbus RS485 intrinsically safe
	3	B	
	4	L-	Supply voltage, intrinsically safe
	5		Grounding/shielding <sup>1)</sup>
Coding		Plug/socket	
A		Plug	

1) Not assigned for order code for "Housing", option C "Ultra-compact, hygienic, stainless"

-  Recommended socket: Binder, series 763, part no. 79 3439 12 05
- When using the device in a hazardous location: Use a suitably certified socket.

Device plug for signal transmission (device side), MODBUS RS485 (not intrinsically safe)

-  For use in the non-hazardous area and Zone 2/Div. 2.

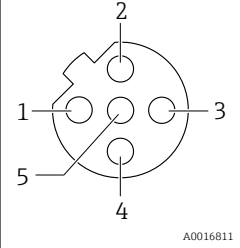
	Pin	Assignment	
	1		Not assigned
	2	A	Modbus RS485
	3		Not assigned
	4	B	Modbus RS485
	5		Grounding/shielding <sup>1)</sup>
Coding		Plug/socket	
B		Socket	

1) Not assigned for order code for "Housing", option C "Ultra-compact, hygienic, stainless"

-  Recommended plug: Binder, series 763, part no. 79 4449 20 05
- When using the device in a hazardous location, use a suitably certified plug.

### Ethernet/IP

Device plug for signal transmission (device side)

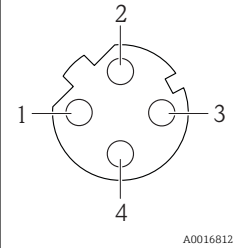
	Pin	Assignment	
	1	+	Tx
	2	+	Rx
	3	-	Tx
	4	-	Rx
	Coding		Plug/socket
D		Socket	

-  Recommended plug:
  - Binder, series 763, part no. 99 3729 810 04
  - Phoenix, part no. 1543223 SACC-M12MSD-4Q
  - When using the device in a hazardous location, use a suitably certified plug.

### PROFINET

Device plug for signal transmission (device side)

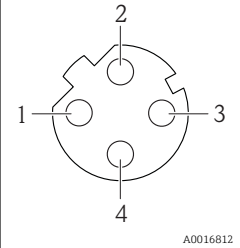
	Pin	Assignment	
	1	+	TD +
	2	+	RD +
	3	-	TD -
	4	-	RD -
	Coding		Plug/socket
D		Socket	

-  Recommended plug:
  - Binder, series 763, part no. 99 3729 810 04
  - Phoenix, part no. 1543223 SACC-M12MSD-4Q
  - When using the device in a hazardous location, use a suitably certified plug.

**Supply voltage**

The power unit must be tested to ensure it meets safety requirements (e.g. PELV, SELV).

**Transmitter**

For device version with communication type:

- HART, PROFIBUS DP, EtherNet/IP: DC 20 to 30 V
- Modbus RS485, device version:
  - For use in the non-hazardous area and Zone 2/Div. 2: DC 20 to 30 V
  - For use in the intrinsically safe area: power supply via Safety Barrier Promass 100

**Promass 100 safety barrier**

DC 20 to 30 V

**Power consumption****Transmitter**

Order code for "Output"	Maximum Power consumption
Option <b>B</b> : 4-20 mA HART with pulse/frequency/switch output	3.5 W
Option <b>L</b> : PROFIBUS DP	3.5 W
Option <b>M</b> Modbus RS485, for use in non-hazardous areas and Zone 2/Div. 2	3.5 W
Option <b>M</b> : Modbus RS485, for use in intrinsically safe areas	2.45 W
Option <b>N</b> : EtherNet/IP	3.5 W
Option <b>R</b> : PROFINET	3.5 W

*Promass 100 safety barrier*

Order code for "Output"	Maximum Power consumption
Option <b>M</b> : Modbus RS485, for use in intrinsically safe areas	4.8 W

**Current consumption****Transmitter**

Order code for "Output"	Maximum Current consumption	Maximum switch-on current
Option <b>B</b> : 4-20mA HART, pul./freq./switch output	145 mA	18 A (< 0.125 ms)
Option <b>L</b> : PROFIBUS DP	145 mA	18 A (< 0.125 ms)
Option <b>M</b> Modbus RS485, for use in non-hazardous areas and Zone 2/Div. 2	90 mA	10 A (< 0.8 ms)
Option <b>M</b> : Modbus RS485, for use in intrinsically safe areas	145 mA	16 A (< 0.4 ms)
Option <b>N</b> : EtherNet/IP	145 mA	18 A (< 0.125 ms)
Option <b>R</b> : PROFINET	145 mA	18 A (< 0.125 ms)

**Promass 100 safety barrier**

Order code for "Output"	Maximum Current consumption	Maximum switch-on current
Option <b>M</b> : Modbus RS485, for use in intrinsically safe areas	230 mA	10 A (< 0.8 ms)

**Power supply failure**

- Totalizers stop at the last value measured.
- Depending on the device version, the configuration is retained in the device memory or in the pluggable data memory (HistoROM DAT).
- Error messages (incl. total operated hours) are stored.



Electrical connection

Connecting the transmitter

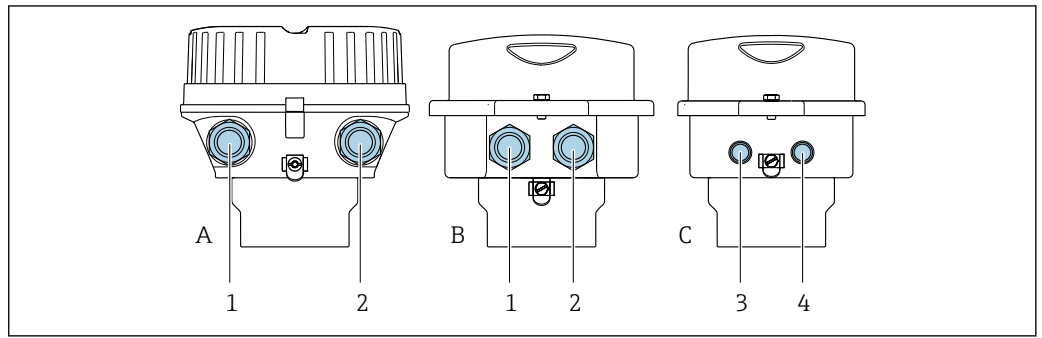

A0016924

- A Housing version: compact, coated, aluminum
- B Housing version: compact, hygienic, stainless
- 1 Cable entry or device plug for signal transmission
- 2 Cable entry or device plug for supply voltage
- C Housing version: ultra-compact, hygienic, stainless, M12 device plug
- 3 Device plug for signal transmission
- 4 Device plug for supply voltage

- i** ■ Terminal assignment → 22
- Pin assignment, device plug → 29

**i** In the case of device versions with a connector, the transmitter housing does not need to be opened to connect the signal cable or power supply cable.

Connection examples

Current output 4 to 20 mA HART

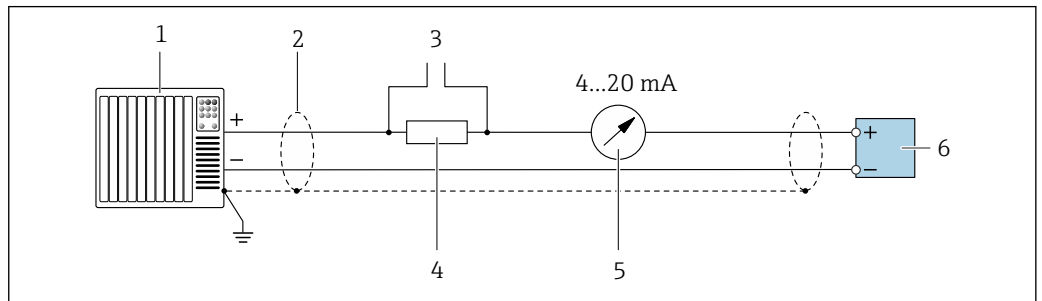

A0029055

**9** Connection example for 4 to 20 mA HART current output (active)

- 1 Automation system with current input (e.g. PLC)
- 2 Cable shield provided at one end. The cable shield must be grounded at both ends to comply with EMC requirements; observe cable specifications → 37
- 3 Connection for HART operating devices → 66
- 4 Resistor for HART communication ( $\geq 250 \Omega$ ): observe maximum load
- 5 Analog display unit: observe maximum load
- 6 Transmitter

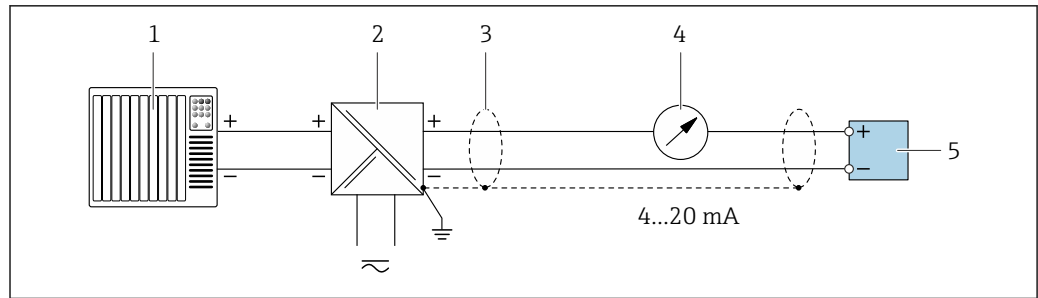

A0028762

10 Connection example for 4 to 20 mA HART current output (passive)

- 1 Automation system with current input (e.g. PLC)
- 2 Power supply
- 3 Cable shield provided at one end. The cable shield must be grounded at both ends to comply with EMC requirements; observe cable specifications → 37
- 4 Analog display unit: observe maximum load
- 5 Transmitter

Pulse/frequency output

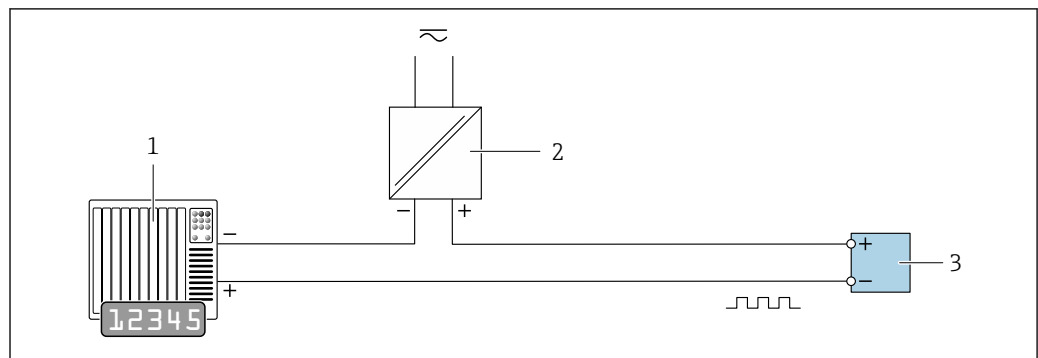

A0028761

11 Connection example for pulse/frequency output (passive)

- 1 Automation system with pulse/frequency input (e.g. PLC)
- 2 Power supply
- 3 Transmitter: Observe input values → 8

Switch output

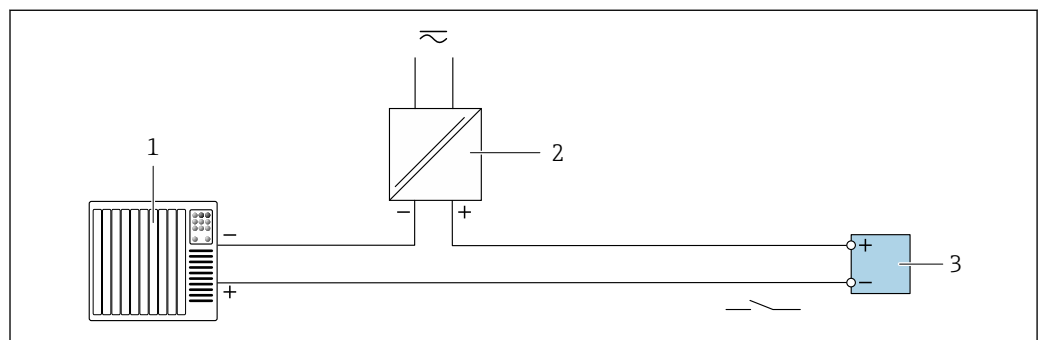

A0028760

12 Connection example for switch output (passive)

- 1 Automation system with switch input (e.g. PLC)
- 2 Power supply
- 3 Transmitter: Observe input values

PROFIBUS DP

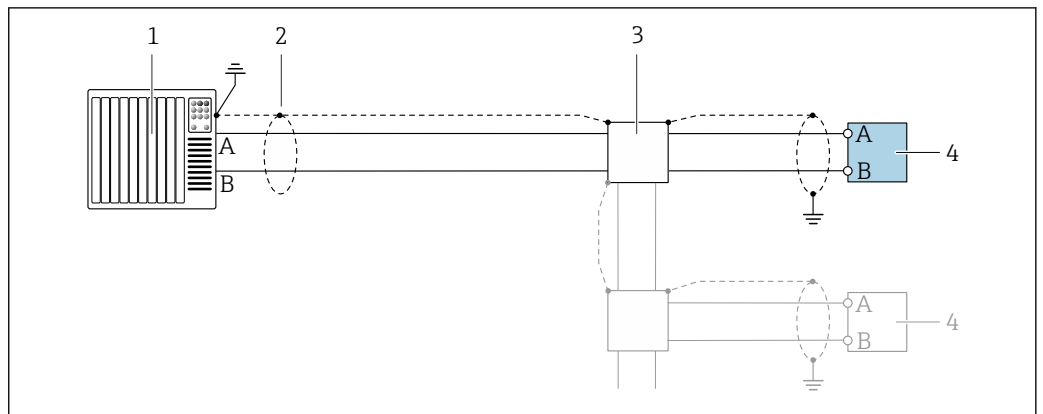

A0028765

13 Connection example for PROFIBUS DP, non-hazardous area and Zone 2/Div. 2

- 1 Control system (e.g. PLC)
- 2 Cable shield provided at one end. The cable shield must be grounded at both ends to comply with EMC requirements; observe cable specifications
- 3 Distribution box
- 4 Transmitter

**i** If baud rates > 1.5 MBaud an EMC cable entry must be used and the cable shield must continue as far as the terminal wherever possible.

Modbus RS485

Modbus RS485 intrinsically safe

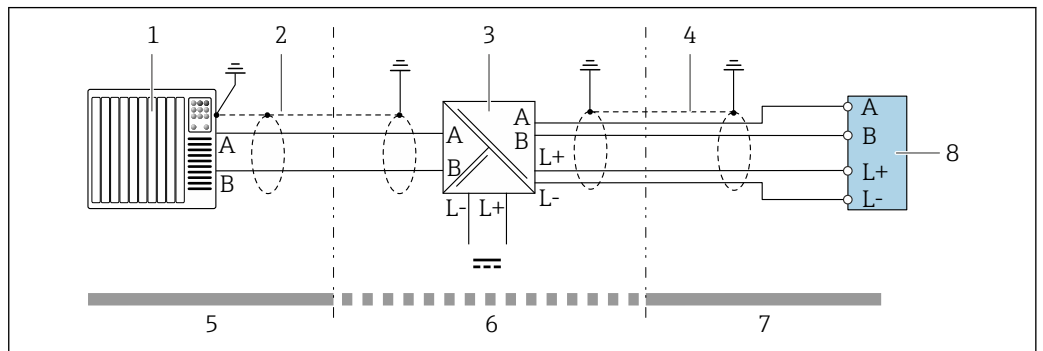

A0028766

14 Connection example for Modbus RS485 intrinsically safe

- 1 Control system (e.g. PLC)
- 2 Cable shield provided at one end. Observe cable specifications
- 3 Safety Barrier Promass 100
- 4 Observe cable specifications
- 5 Non-hazardous area
- 6 Non-hazardous area and Zone 2/Div. 2
- 7 Intrinsically safe area
- 8 Transmitter

*EtherNet/IP*

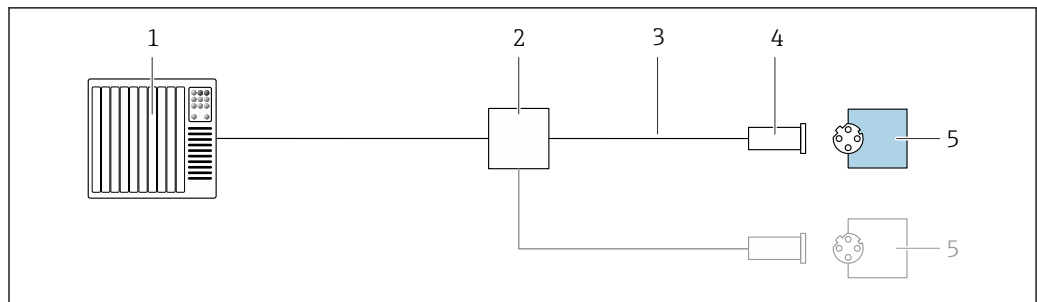

A0028767

15 Connection example for EtherNet/IP

- 1 Control system (e.g. PLC)
- 2 Ethernet switch
- 3 Observe cable specifications
- 4 Device plug
- 5 Transmitter

*PROFINET*

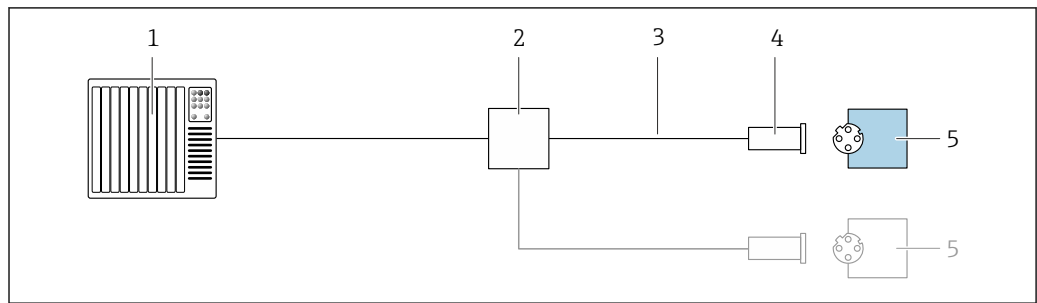

A0028767

16 Connection example for PROFINET

- 1 Control system (e.g. PLC)
- 2 Ethernet switch
- 3 Observe cable specifications
- 4 Device plug
- 5 Transmitter

*HART input*

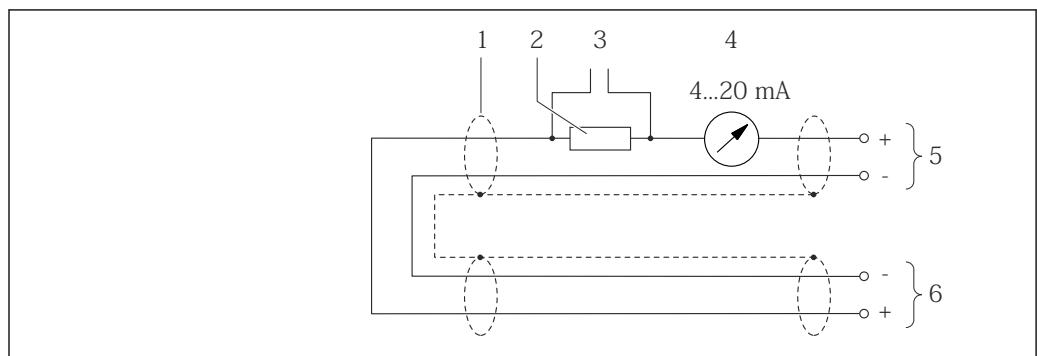

A0019828

17 Connection example for HART input (burst mode) via current output (active)

- 1 Cable shield provided at one end. Observe cable specifications
- 2 Resistor for HART communication ( $\geq 250 \Omega$ ): observe maximum load
- 3 Connection for HART operating devices
- 4 Analog display unit
- 5 Transmitter
- 6 Sensor for external measured variable

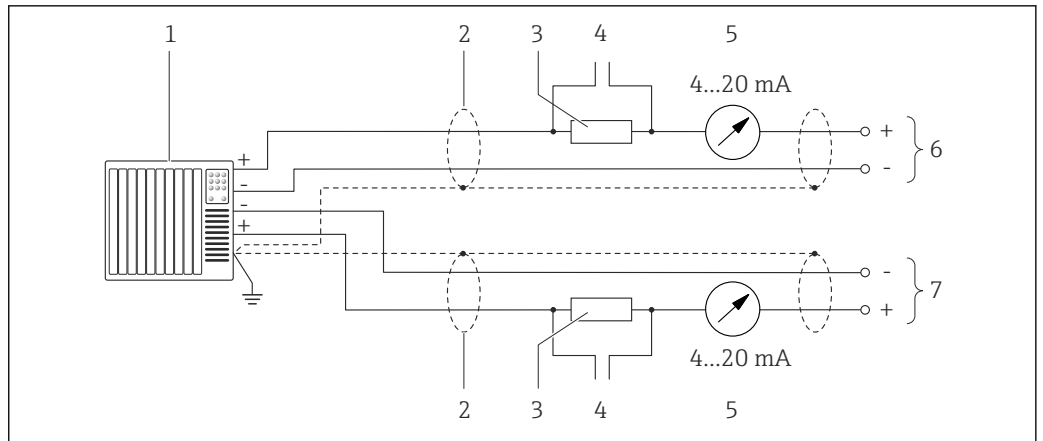

18 Connection example for HART input (master mode) via current output (active)

- 1 Automation system with current input (e.g. PLC).  
Prerequisite: automation system with HART version 6, HART commands 113 and 114 can be processed.
- 2 Cable shield provided at one end. Observe cable specifications
- 3 Resistor for HART communication ( $\geq 250 \Omega$ ): observe maximum load
- 4 Connection for HART operating devices
- 5 Analog display unit
- 6 Transmitter
- 7 Sensor for external measured variable

**Potential equalization**

**Requirements**

No special measures for potential equalization are required.

Please consider the following to ensure correct measurement:

- Same electrical potential for the fluid and sensor
- Company-internal grounding concepts

 For devices intended for use in hazardous locations, please observe the guidelines in the Ex documentation (XA).

**Terminals**

**Transmitter**

Spring terminals for wire cross-sections 0.5 to 2.5 mm<sup>2</sup> (20 to 14 AWG)

**Promass 100 safety barrier**

Plug-in screw terminals for wire cross-sections 0.5 to 2.5 mm<sup>2</sup> (20 to 14 AWG)

**Cable entries**

- Cable gland: M20 × 1.5 with cable Ø 6 to 12 mm (0.24 to 0.47 in)
- Thread for cable entry:
  - M20
  - G ½"
  - NPT ½"

**Cable specification**

**Permitted temperature range**

- The installation guidelines that apply in the country of installation must be observed.
- The cables must be suitable for the minimum and maximum temperatures to be expected.

**Power supply cable (incl. conductor for the inner ground terminal)**

Standard installation cable is sufficient.

**Signal cable**

*Current output 4 to 20 mA HART*

A shielded cable is recommended. Observe grounding concept of the plant.

*Pulse/frequency/switch output*

Standard installation cable is sufficient.

*PROFIBUS DP*

The IEC 61158 standard specifies two types of cable (A and B) for the bus line which can be used for every transmission rate. Cable type A is recommended.

<b>Cable type</b>	A
<b>Characteristic impedance</b>	135 to 165 $\Omega$ at a measuring frequency of 3 to 20 MHz
<b>Cable capacitance</b>	< 30 pF/m
<b>Wire cross-section</b>	> 0.34 mm <sup>2</sup> (22 AWG)
<b>Cable type</b>	Twisted pairs
<b>Loop resistance</b>	$\leq$ 110 $\Omega$ /km
<b>Signal damping</b>	Max. 9 dB over the entire length of the cable cross-section
<b>Shield</b>	Copper braided shielding or braided shielding with foil shield. When grounding the cable shield, observe the grounding concept of the plant.



For further information on planning and installing PROFIBUS networks see:

Operating Instructions "PROFIBUS DP/PA: Guidelines for planning and commissioning" (BA00034S)

*Modbus RS485*

The EIA/TIA-485 standard specifies two types of cable (A and B) for the bus line which can be used for every transmission rate. Cable type A is recommended.

<b>Cable type</b>	A
<b>Characteristic impedance</b>	135 to 165 $\Omega$ at a measuring frequency of 3 to 20 MHz
<b>Cable capacitance</b>	< 30 pF/m
<b>Wire cross-section</b>	> 0.34 mm <sup>2</sup> (22 AWG)
<b>Cable type</b>	Twisted pairs
<b>Loop resistance</b>	$\leq$ 110 $\Omega$ /km
<b>Signal damping</b>	Max. 9 dB over the entire length of the cable cross-section
<b>Shield</b>	Copper braided shielding or braided shielding with foil shield. When grounding the cable shield, observe the grounding concept of the plant.

*EtherNet/IP*

The standard ANSI/TIA/EIA-568-B.2 Annex specifies CAT 5 as the minimum category for a cable used for EtherNet/IP. CAT 5e and CAT 6 are recommended.



For more information on planning and installing EtherNet/IP networks, please refer to the "Media Planning and Installation Manual. EtherNet/IP" of ODVA Organization

*PROFINET*

Standard IEC 61156-6 specifies CAT 5 as the minimum category for a cable used for PROFINET. CAT 5e and CAT 6 are recommended.



For more information on planning and installing PROFINET networks, see: "PROFINET Cabling and Interconnection Technology", Guideline for PROFINET

**Connecting cable between Safety Barrier Promass 100 and measuring device**

<b>Cable type</b>	Shielded twisted-pair cable with 2x2 wires. When grounding the cable shield, observe the grounding concept of the plant.
<b>Maximum cable resistance</b>	2.5 Ω, one side

 Comply with the maximum cable resistance specifications to ensure the operational reliability of the measuring device.



The maximum cable length for individual wire cross-sections is specified in the table below. Observe the maximum capacitance and inductance per unit length of the cable and connection values for hazardous areas .

Wire cross-section		Maximum cable length	
[mm <sup>2</sup> ]	[AWG]	[m]	[ft]
0.5	20	70	230
0.75	18	100	328
1.0	17	100	328
1.5	16	200	656
2.5	14	300	984

**Performance characteristics**

**Reference operating conditions**

- Error limits based on ISO 11631
- Water with +15 to +45 °C (+59 to +113 °F) at 2 to 6 bar (29 to 87 psi)
- Specifications as per calibration protocol
- Accuracy based on accredited calibration rigs that are traced to ISO 17025.

 To obtain measured errors, use the *Applicator* sizing tool →  73

**Maximum measured error**

o.r. = of reading; 1 g/cm<sup>3</sup> = 1 kg/l; T = medium temperature

**Base accuracy**

 Design fundamentals →  42

*Mass flow and volume flow (liquids)*

±0.10 % o.r.

*Mass flow (gases)*

±0.50 % o.r.

*Density (liquids)*

Under reference conditions	Standard density calibration <sup>1)</sup>	Wide-range Density specification <sup>2) 3)</sup>
[g/cm <sup>3</sup> ]	[g/cm <sup>3</sup> ]	[g/cm <sup>3</sup> ]
±0.0005	±0.02	±0.002

- 1) Valid over the entire temperature and density range
- 2) Valid range for special density calibration: 0 to 2 g/cm<sup>3</sup>, +5 to +80 °C (+41 to +176 °F)
- 3) Order code for "Application package", option EE "Special density"

*Temperature*

$$\pm 0.5 \text{ }^\circ\text{C} \pm 0.005 \cdot T \text{ }^\circ\text{C} (\pm 0.9 \text{ }^\circ\text{F} \pm 0.003 \cdot (T - 32) \text{ }^\circ\text{F})$$

**Zero point stability**

DN		Zero point stability	
[mm]	[in]	[kg/h]	[lb/min]
1	$\frac{1}{24}$	0.0008	0.00003
2	$\frac{1}{12}$	0.002	0.00007
4	$\frac{1}{8}$	0.014	0.0005
6	$\frac{1}{4}$	0.02	0.0007

**Flow values**

Flow values as turndown parameter depending on nominal diameter.

*SI units*

DN [mm]	1:1	1:10	1:20	1:50	1:100	1:500
	[kg/h]	[kg/h]	[kg/h]	[kg/h]	[kg/h]	[kg/h]
1	20	2	1	0.4	0.2	0.04
2	100	10	5	2	1	0.2
4	450	45	22.5	9	4.5	0.9
6	1000	100	50	20	10	2

*US units*

DN [inch]	1:1	1:10	1:20	1:50	1:100	1:500
	[lb/min]	[lb/min]	[lb/min]	[lb/min]	[lb/min]	[lb/min]
$\frac{1}{24}$	0.735	0.074	0.037	0.015	0.007	0.001
$\frac{1}{12}$	3.675	0.368	0.184	0.074	0.037	0.007
$\frac{1}{8}$	16.54	1.654	0.827	0.331	0.165	0.033
$\frac{1}{4}$	36.75	3.675	1.838	0.735	0.368	0.074

**Accuracy of outputs**

 The output accuracy must be factored into the measured error if analog outputs are used, but can be ignored for fieldbus outputs (e.g. Modbus RS485, EtherNet/IP).

The outputs have the following base accuracy specifications.

*Current output*

<b>Accuracy</b>	Max. $\pm 5 \mu\text{A}$
-----------------	--------------------------

*Pulse/frequency output*

o.r. = of reading

<b>Accuracy</b>	Max. $\pm 50 \text{ ppm o.r.}$ (over the entire ambient temperature range)
-----------------	--

**Repeatability**

o.r. = of reading;  $1 \text{ g/cm}^3 = 1 \text{ kg/l}$ ; T = medium temperature



**Base repeatability**

 Design fundamentals →  42

*Mass flow and volume flow (liquids)*

±0.05 % o.r.

*Mass flow (gases)*

±0.25 % o.r.

*Density (liquids)*

±0.00025 g/cm<sup>3</sup>

*Temperature*

±0.25 °C ± 0.0025 · T °C (±0.45 °F ± 0.0015 · (T-32) °F)

**Response time**

The response time depends on the configuration (damping).

**Influence of ambient temperature**

**Current output**

o.r. = of reading

<b>Temperature coefficient</b>	Max. ±0.005 % o.r./°C
--------------------------------	-----------------------

**Pulse/frequency output**

<b>Temperature coefficient</b>	No additional effect. Included in accuracy.
--------------------------------	---

**Influence of medium temperature**

**Mass flow and volume flow**

o.f.s. = of full scale value

When there is a difference between the temperature for zero point adjustment and the process temperature, the additional measured error of the sensor is typically ±0.0002 % o.f.s./°C (±0.0001 % o. f.s./°F).

The effect is reduced if zero point adjustment is performed at process temperature.

**Density**

When there is a difference between the density calibration temperature and the process temperature, the typical measured error of the sensor is

±0.00005 g/cm<sup>3</sup> /°C (±0.000025 g/cm<sup>3</sup> /°F). Field density calibration is possible.

**Wide-range density specification (special density calibration)**

If the process temperature is outside the valid range (→  39) the measured error is ±0.00005 g/cm<sup>3</sup> /°C (±0.000025 g/cm<sup>3</sup> /°F)

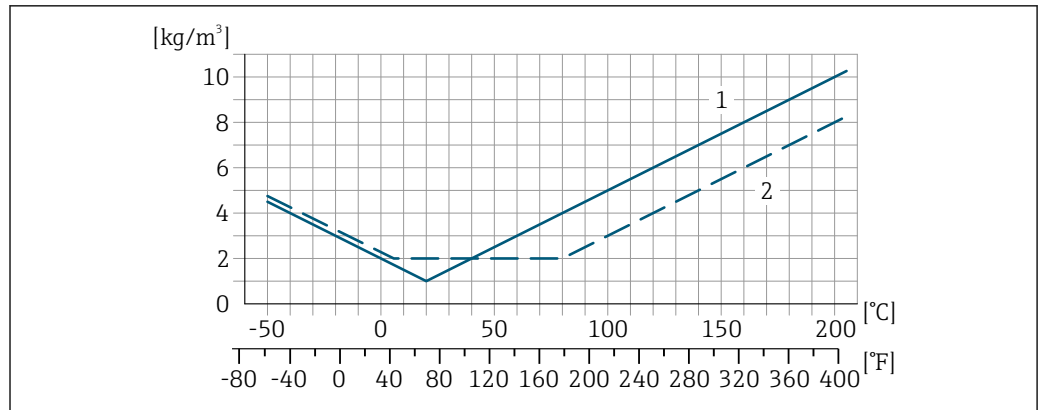

A0016617

- 1 Field density calibration, for example at +20 °C (+68 °F)
- 2 Special density calibration

**Temperature**

$\pm 0.005 \cdot T \text{ } ^\circ\text{C}$  ( $\pm 0.005 \cdot (T - 32) \text{ } ^\circ\text{F}$ )

**Influence of medium pressure**

The table below shows the effect on accuracy of mass flow due to a difference between calibration pressure and process pressure.

o.r. = of reading



It is possible to compensate for the effect by:

- Reading in the current pressure measured value via the current input.
- Specifying a fixed value for the pressure in the device parameters.



Operating Instructions.

DN		[% o.r./bar]	[% o.r./psi]
[mm]	[in]		
1	1/24	-0.001	-0.00007
2	1/12	0	0
4	1/8	-0.005	-0.0004
6	1/4	-0.003	-0.0002

**Design fundamentals**

o.r. = of reading, o.f.s. = of full scale value

BaseAccu = base accuracy in % o.r., BaseRepeat = base repeatability in % o.r.

MeasValue = measured value; ZeroPoint = zero point stability

Calculation of the maximum measured error as a function of the flow rate

Flow rate	Maximum measured error in % o.r.
$\geq \frac{\text{ZeroPoint}}{\text{BaseAccu}} \cdot 100$ <small>A0021332</small>	$\pm \text{BaseAccu}$ <small>A0021339</small>
$< \frac{\text{ZeroPoint}}{\text{BaseAccu}} \cdot 100$ <small>A0021333</small>	$\pm \frac{\text{ZeroPoint}}{\text{MeasValue}} \cdot 100$ <small>A0021334</small>

Calculation of the maximum repeatability as a function of the flow rate

Flow rate	Maximum repeatability in % o.r.
$\geq \frac{1/2 \cdot \text{ZeroPoint}}{\text{BaseRepeat}} \cdot 100$ <small>A0021335</small>	$\pm \text{BaseRepeat}$ <small>A0021340</small>
$< \frac{1/2 \cdot \text{ZeroPoint}}{\text{BaseRepeat}} \cdot 100$ <small>A0021336</small>	$\pm 1/2 \cdot \frac{\text{ZeroPoint}}{\text{MeasValue}} \cdot 100$ <small>A0021337</small>

**Example for maximum measured error**

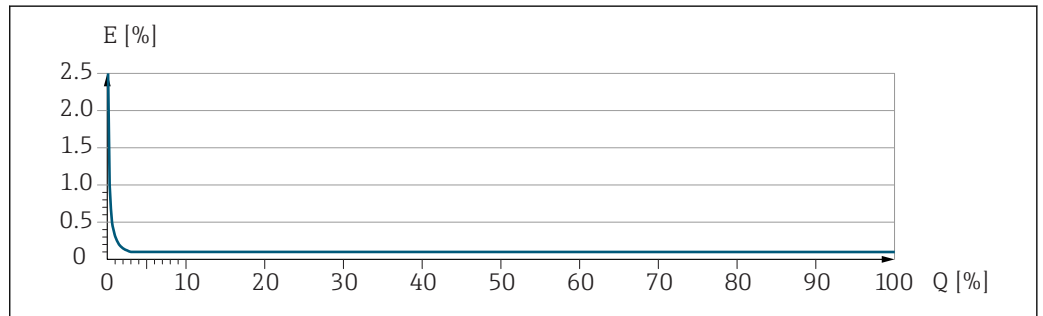

E Maximum measured error in % o.r. (example)  
 Q Flow rate in % of maximum full scale value

**Installation**

**Mounting location**

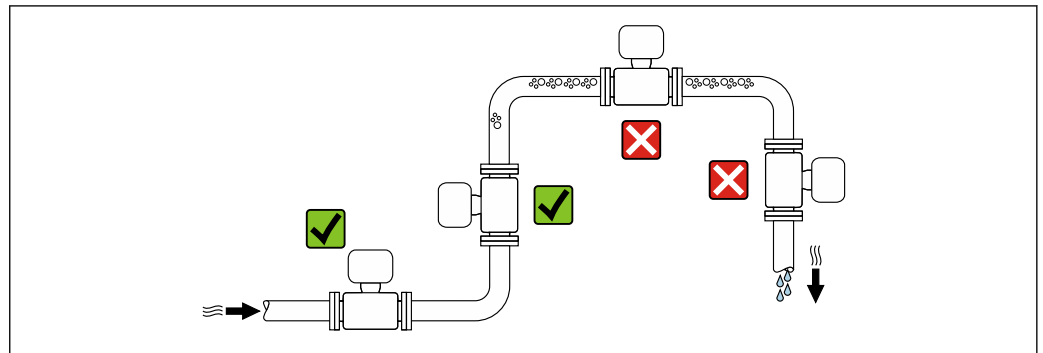

To prevent measuring errors arising from accumulation of gas bubbles in the measuring tube, avoid the following mounting locations in the pipe:

- Highest point of a pipeline.
- Directly upstream of a free pipe outlet in a down pipe.

**Installation in down pipes**

However, the following installation suggestion allows for installation in an open vertical pipeline. Pipe restrictions or the use of an orifice with a smaller cross-section than the nominal diameter prevent the sensor running empty while measurement is in progress.

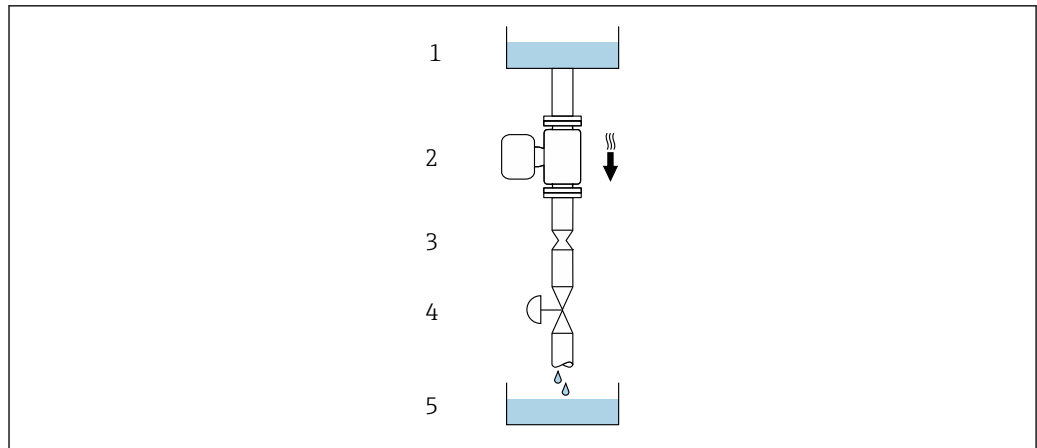

A0028773

19 Installation in a down pipe (e.g. for batching applications)

- 1 Supply tank
- 2 Sensor
- 3 Orifice plate, pipe restriction
- 4 Valve
- 5 Batching tank

DN		Ø orifice plate, pipe restriction	
[mm]	[in]	[mm]	[in]
1	1/24	0.8	0.03
2	1/12	1.5	0.06
4	1/8	3.0	0.12
6	1/4	5.0	0.20

**Orientation**

The direction of the arrow on the sensor nameplate helps you to install the sensor according to the flow direction (direction of medium flow through the piping).

Orientation		Recommendation
<b>A</b>	Vertical orientation  A0015591	☑☑
<b>B</b>	Horizontal orientation, transmitter at top  A0015589	☑☑ <sup>1)</sup>
<b>C</b>	Horizontal orientation, transmitter at bottom  A0015590	☑☑ <sup>2)</sup>
<b>D</b>	Horizontal orientation, transmitter at side  A0015592	☒

- 1) Applications with low process temperatures may decrease the ambient temperature. To maintain the minimum ambient temperature for the transmitter, this orientation is recommended.
- 2) Applications with high process temperatures may increase the ambient temperature. To maintain the maximum ambient temperature for the transmitter, this orientation is recommended.

**Inlet and outlet runs**

No special precautions need to be taken for fittings which create turbulence, such as valves, elbows or T-pieces, as long as no cavitation occurs → 51.

**Special mounting instructions**

**Sanitary compatibility**

 When installing in hygienic applications, please refer to the information in the "Certificates and approvals/hygienic compatibility" section

**Rupture disk**

Information that is relevant to the process: →  50.

**⚠ WARNING**

**Danger from medium escaping!**

Medium escaping under pressure can cause injury or material damage.

- ▶ Take precautions to prevent danger to persons and damage if the rupture disk is actuated.
- ▶ Observe information on the rupture disk sticker.
- ▶ Make sure that the function and operation of the rupture disk is not impeded through the installation of the device.
- ▶ Do not use a heating jacket.
- ▶ Do not remove or damage the rupture disk.

The position of the rupture disk is indicated on a sticker beside it.

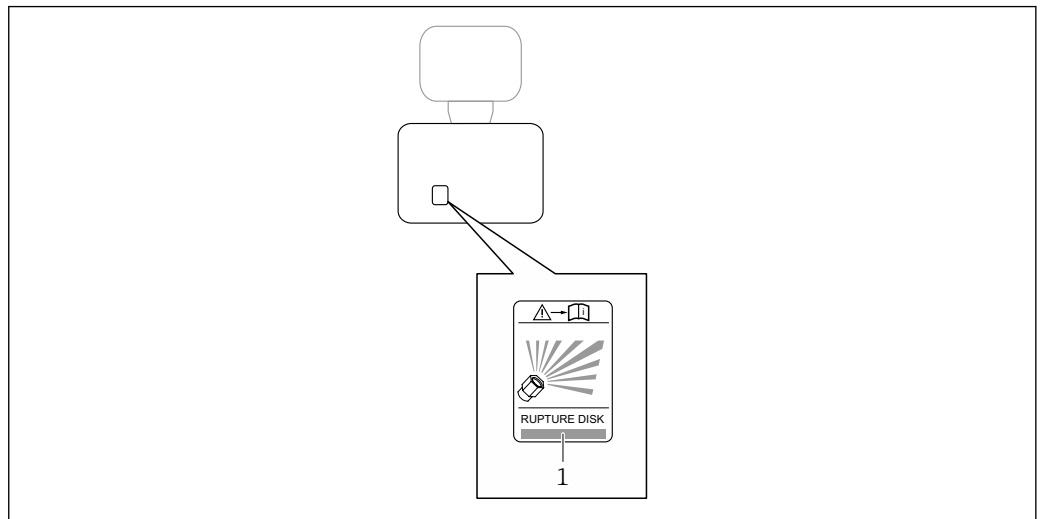

A0029940

1 Rupture disk label

**Wall mounting**

**⚠ WARNING**

**Incorrect sensor mounting**

Risk of injury if measuring tube breaks

- ▶ The sensor should never be installed in a pipe in a way that it is freely suspended
- ▶ Using the base plate, mount the sensor directly on the floor, wall or ceiling.
- ▶ Support the sensor on a securely mounted support base (e.g. angle bracket).

The following mounting versions are recommended for the installation.

**Vertical**

- Mounted directly on a wall using the base plate, or
- Device supported on an angle bracket mounted on the wall

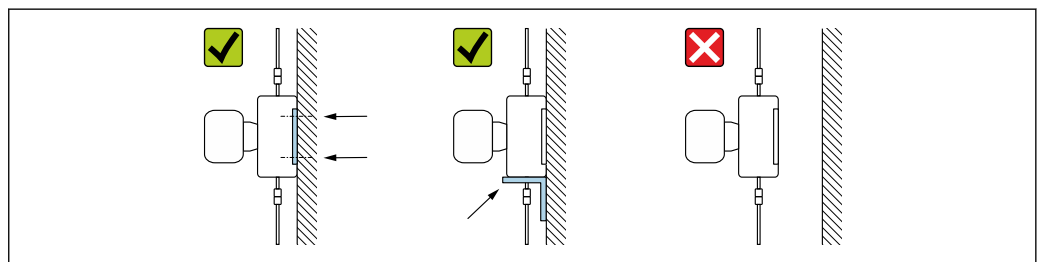

A0030286

**Horizontal**

Device standing on a solid support base

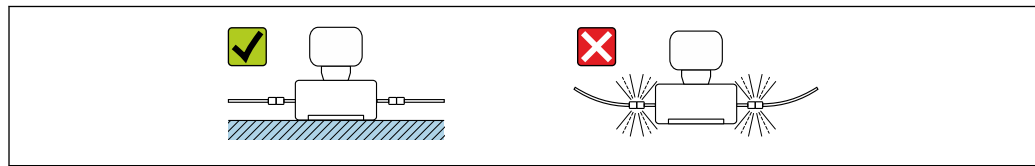

A0030287

**Mounting plate**

The universal mounting plate can be used to affix or place the unit on a flat surface (order code for "Accessories", option PA).

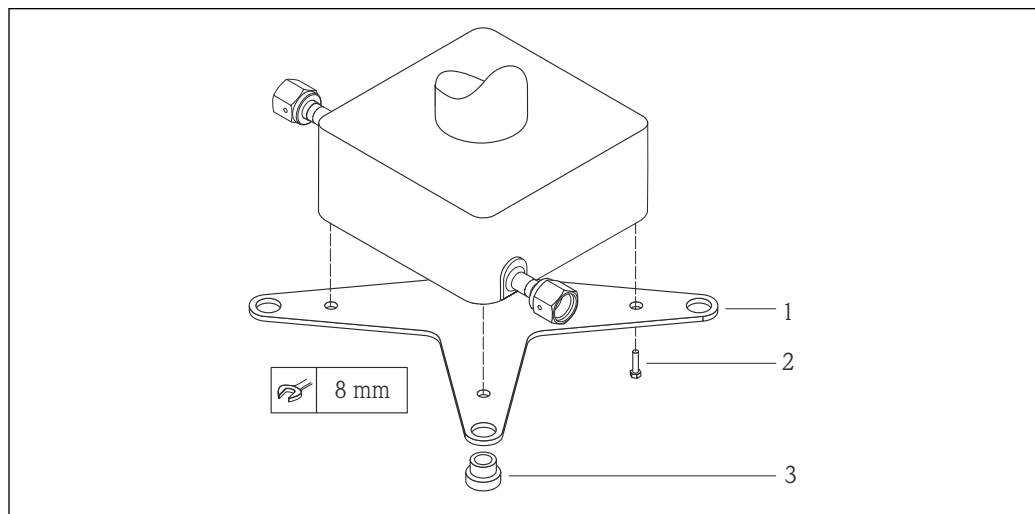

A0019768

**20** *Mounting kit for Cubemass mounting plate*

- 1 1 x Cubemass mounting plate
- 2 4 x screw M5 x 8
- 3 4 x grommet

**Zero point adjustment**

All measuring devices are calibrated in accordance with state-of-the-art technology. Calibration takes place under reference conditions → 39. Therefore, a zero point adjustment in the field is generally not required.

Experience shows that zero point adjustment is advisable only in special cases:

- To achieve maximum measuring accuracy even with low flow rates.
- Under extreme process or operating conditions (e.g. very high process temperatures or very high-viscosity fluids).

**Installing the Safety Barrier Promass 100**

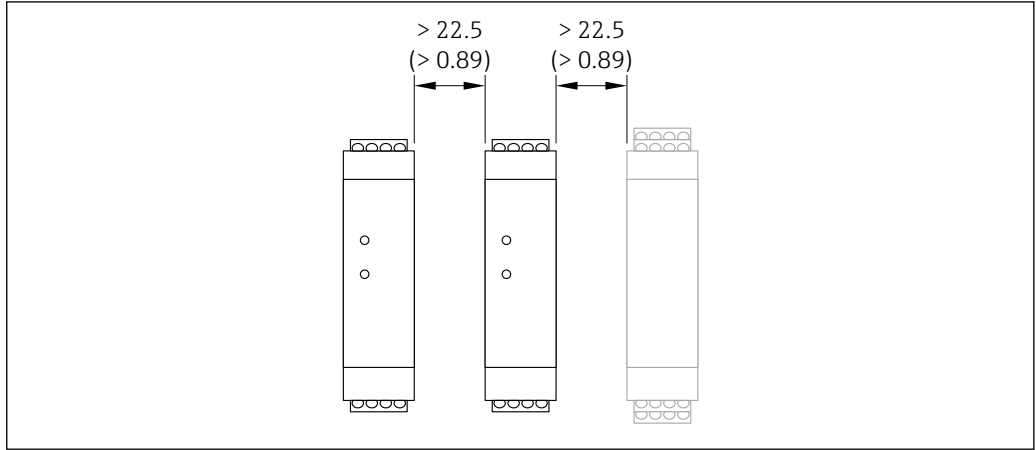

21 Minimum distance between additional Safety Barrier Promass 100 or other modules. Engineering unit mm (in)

**Environment**

**Ambient temperature range**

Measuring device	<ul style="list-style-type: none"> <li>■ -40 to +60 °C (-40 to +140 °F)</li> <li>■ Order code for "Test, certificate", option JM: -50 to +60 °C (-58 to +140 °F)</li> </ul>
Safety Barrier Promass 100	-40 to +60 °C (-40 to +140 °F)

- ▶ If operating outdoors:  
Avoid direct sunlight, particularly in warm climatic regions.

**Storage temperature**

-40 to +80 °C (-40 to +176 °F), preferably at +20 °C (+68 °F) (standard version)  
-50 to +80 °C (-58 to +176 °F) (Order code for "Test, certificate", option JM)

**Climate class**

DIN EN 60068-2-38 (test Z/AD)

**Degree of protection**

**Transmitter and sensor**

- As standard: IP66/67, type 4X enclosure
- When housing is open: IP20, type 1 enclosure
- Display module: IP20, type 1 enclosure

**Safety Barrier Promass 100**  
IP20

**Vibration- and shock-resistance**

**Vibration sinusoidal, in accordance with IEC 60068-2-6**

- 2 to 8.4 Hz, 3.5 mm peak
- 8.4 to 2 000 Hz, 1 g peak

**Vibration broad-band random, according to IEC 60068-2-64**

- 10 to 200 Hz, 0.003 g<sup>2</sup>/Hz
- 200 to 2 000 Hz, 0.001 g<sup>2</sup>/Hz
- Total: 1.54 g rms

**Shock half-sine, according to IEC 60068-2-27**  
6 ms 30 g

**Rough handling shocks, according to IEC 60068-2-31**

**Interior cleaning**

- Cleaning in place (CIP)
- Sterilization in place (SIP)

**Options**

Oil- and grease-free version for wetted parts, without declaration  
Order code for "Service", option HA

**Electromagnetic compatibility (EMC)**

- Depends on the communication protocol:
  - HART, PROFIBUS DP, EtherNet/IP:  
As per IEC/EN 61326 and NAMUR Recommendation 21 (NE 21)
  - Modbus RS485:  
As per IEC/EN 61326 and NAMUR Recommendation 21 (NE 21)
  - PROFINET: as per IEC/EN 61326
- Complies with emission limits for industry as per EN 55011 (Class A)
- Device version with PROFIBUS DP: Complies with emission limits for industry as per EN 50170 Volume 2, IEC 61784

 The following applies for PROFIBUS DP: If baud rates > 1.5 Mbaud, an EMC cable entry must be used and the cable shield must continue as far as the terminal wherever possible.

 Details are provided in the Declaration of Conformity.

**Process**

**Medium temperature range** -50 to +205 °C (-58 to +401 °F)

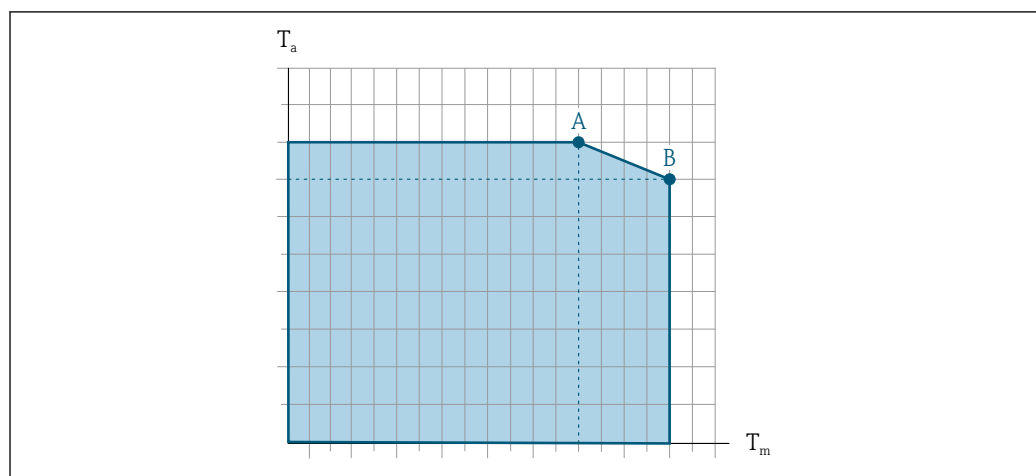
**Dependency of ambient temperature on medium temperature**

 22 Exemplary representation, values in the table below.

$T_a$  Ambient temperature range

$T_m$  Medium temperature

A Maximum permitted medium temperature  $T_m$  at  $T_{a\ max} = 60\ ^\circ\text{C}$  (140 °F); higher medium temperatures  $T_m$  require a reduced ambient temperature  $T_a$

B Maximum permitted ambient temperature  $T_a$  for the maximum specified medium temperature  $T_m$  of the sensor

 Values for devices used in the hazardous area:  
Separate Ex documentation (XA) for the device .



**Seals**

For mounting sets with screwed-on connections:

- Viton: -15 to +200 °C (-5 to +392 °F)
- EPDM: -40 to +160 °C (-40 to +320 °F)
- Silicon: -60 to +200 °C (-76 to +392 °F)
- Kalrez: -20 to +275 °C (-4 to +527 °F)

**Density** 0 to 5 000 kg/m<sup>3</sup> (0 to 312 lb/cf)

**Pressure-temperature ratings**

The following pressure/temperature diagrams apply to all pressure-bearing parts of the device and not just the process connection. The diagrams show the maximum permissible medium pressure depending on the specific medium temperature.

**Flange connection according to EN 1092-1 (DIN 2501)**

Order code for "Mounting kit", option PE

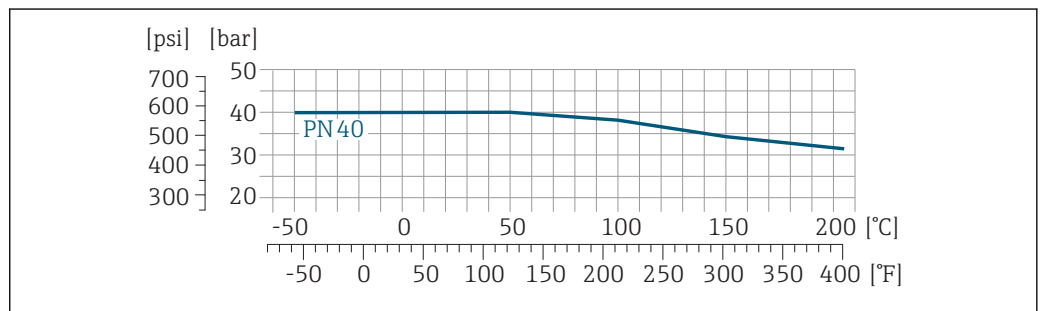

23 With flange material: 1.4539 (904L), Alloy C22; lap joint flanges (not wetted) 1.4404 (316/316L)

**Flange connection according to ASME B16.5**

Order code for "Mounting kit", option PF, PG

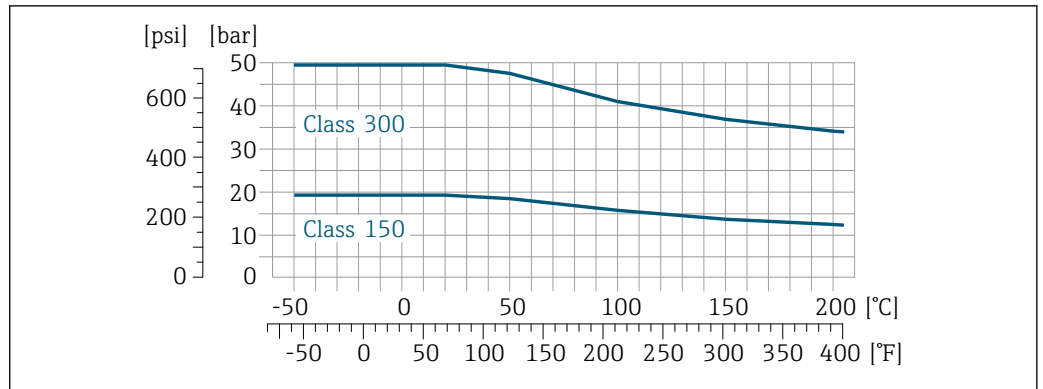

24 With flange material: 1.4539 (904L); lap joint flanges (not wetted) 1.4404 (316/316L)

**Flange connection according to JIS B2220**

Order code for "Mounting kit", option PH

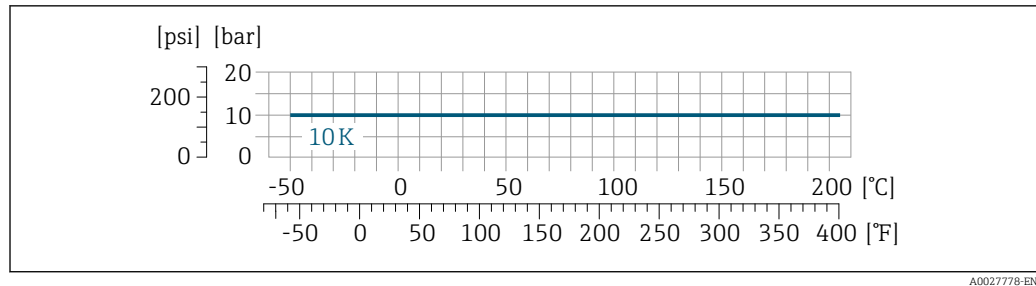

A0027778-EN

☒ 25 With flange material: 1.4539 (904L); lap joint flanges (not wetted): 1.4404 (316/316L)

### Process connection 4-VCO-4, ¼ NPTF (DN 1 to 4); 8-VCO-4, ½ NPTF (DN 6)

Order code for "Mounting kit", option PC, PD

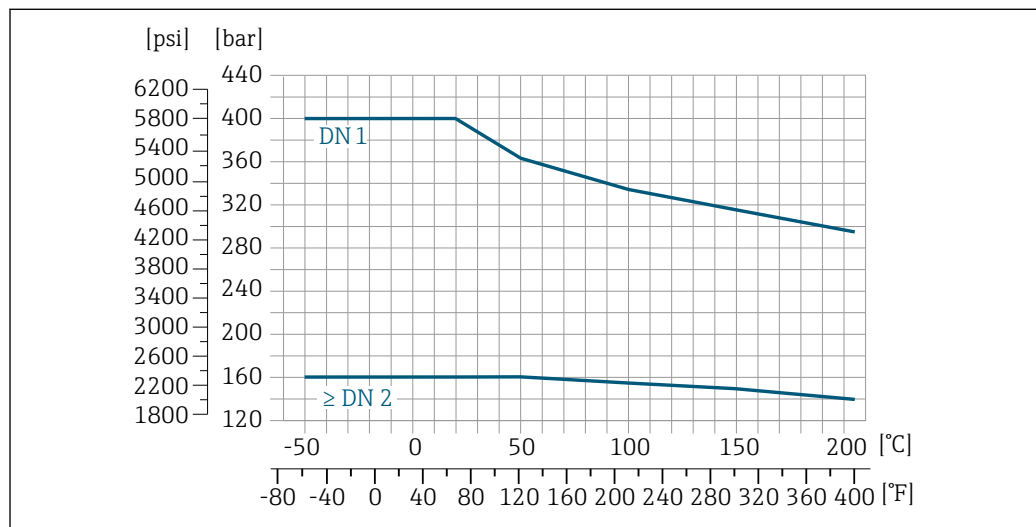

A0027774-EN

☒ 26 4-VCO-4 coupling: 1.4539 (904L); 8-VCO-4 coupling: 1.4539 (904L); NPTF threaded adapter: 1.4539 (904L)

### Sensor housing

The sensor housing is filled with dry nitrogen gas and protects the electronics and mechanics inside.

### Rupture disk

To guarantee the safety of the measuring device, the device version with a rupture disk with a triggering pressure of 10 to 15 bar (145 to 217.5 psi) is the standard version used. Special mounting instructions → ☒ 45.

### Flow limit

Select the nominal diameter by optimizing between the required flow range and permissible pressure loss.

☒ For an overview of the full scale values for the measuring range, see the "Measuring range" section → ☒ 7

- The minimum recommended full scale value is approx. 1/20 of the maximum full scale value
- In most applications, 20 to 50 % of the maximum full scale value can be considered ideal
- A low full scale value must be selected for abrasive media (such as liquids with entrained solids): flow velocity < 1 m/s (< 3 ft/s).
- For gas measurement the following rules apply:
  - The flow velocity in the measuring tubes should not exceed half the sound velocity (0.5 Mach).
  - The maximum mass flow depends on the density of the gas: formula → ☒ 7

☒ To calculate the flow limit, use the *Applicator* sizing tool → ☒ 73

### Pressure loss

☒ To calculate the pressure loss, use the *Applicator* sizing tool → ☒ 73

**System pressure**

It is important that cavitation does not occur, or that gases entrained in the liquids do not outgas. This is prevented by means of a sufficiently high system pressure.

For this reason, the following mounting locations are recommended:

- At the lowest point in a vertical pipe
- Downstream from pumps (no danger of vacuum)

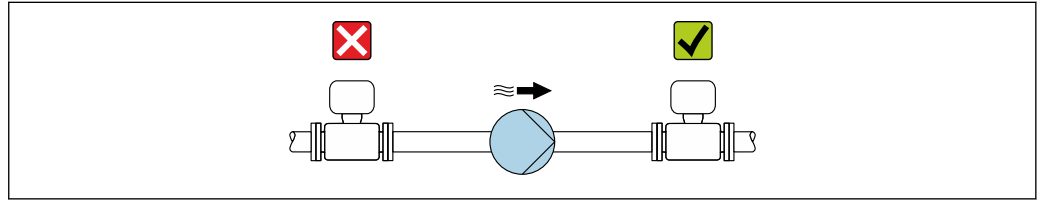

A0028777

**Thermal insulation**

In the case of some fluids, it is important to keep the heat radiated from the sensor to the transmitter to a low level. A wide range of materials can be used for the required insulation.

**NOTICE****Electronics overheating on account of thermal insulation!**

- ▶ Recommended orientation: horizontal orientation, transmitter housing pointing downwards.
- ▶ Do not insulate the transmitter housing .
- ▶ Maximum permissible temperature at the lower end of the transmitter housing: 80 °C (176 °F)
- ▶ Thermal insulation with extended neck free: We recommend that you do not insulate the extended neck in order to ensure optimum dissipation of heat.

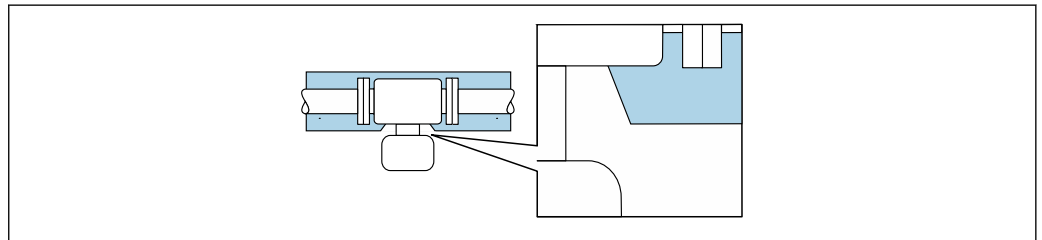

A0034391

27 Thermal insulation with extended neck free

**Heating**

Some fluids require suitable measures to avoid loss of heat at the sensor.

**Heating options**

- Electrical heating, e.g. with electric band heaters
- Via pipes carrying hot water or steam
- Via heating jackets

**NOTICE****Danger of overheating when heating**

- ▶ Ensure that the temperature at the lower end of the transmitter housing does not exceed 80 °C (176 °F).
- ▶ Ensure that sufficient convection takes place at the transmitter neck.
- ▶ Ensure that a sufficiently large area of the transmitter neck remains exposed. The uncovered part serves as a radiator and protects the electronics from overheating and excessive cooling.
- ▶ When using in potentially explosive atmospheres, observe the information in the device-specific Ex documentation. For detailed information on the temperature tables, see the separate document entitled "Safety Instructions" (XA) for the device.

**Vibrations**

The high oscillation frequency of the measuring tubes ensures that the correct operation of the measuring system is not influenced by plant vibrations.

## Mechanical construction

Dimensions in SI units

Compact version

Order code for "Housing", option A "Compact coated alu"

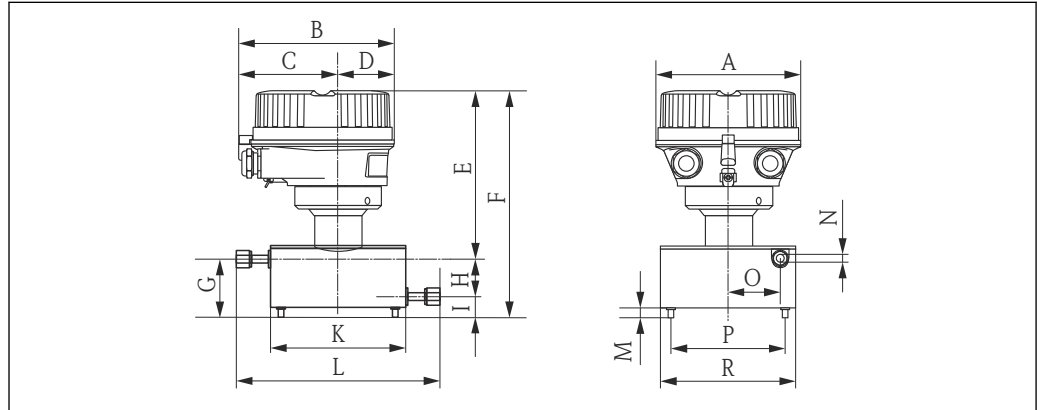

A0019431

DN [mm]	A [mm]	B [mm]	C [mm]	D [mm]	E <sup>1)</sup> [mm]	F <sup>1)</sup> [mm]	G [mm]	H [mm]
1	136	147.5	93.5	54	162	214	52	30
2	136	147.5	93.5	54	162	214	52	30
4	136	147.5	93.5	54	162	214	52	30
6	136	147.5	93.5	54	162	214	52	30

1) If using a display, order code for "Display; operation", option B: values +28 mm

DN [mm]	I [mm]	K [mm]	L [mm]	M [mm]	N [mm]	O [mm]	P [mm]	R [mm]
1	22	120	175	10	1.3	40	90	120
2	22	120	175	10	2	40	90	120
4	22	120	175	10	3.9	40	90	120
6	22	120	175	10	5.35	40	90	120

Order code for "Housing", option B "Compact hygienic, stainless"

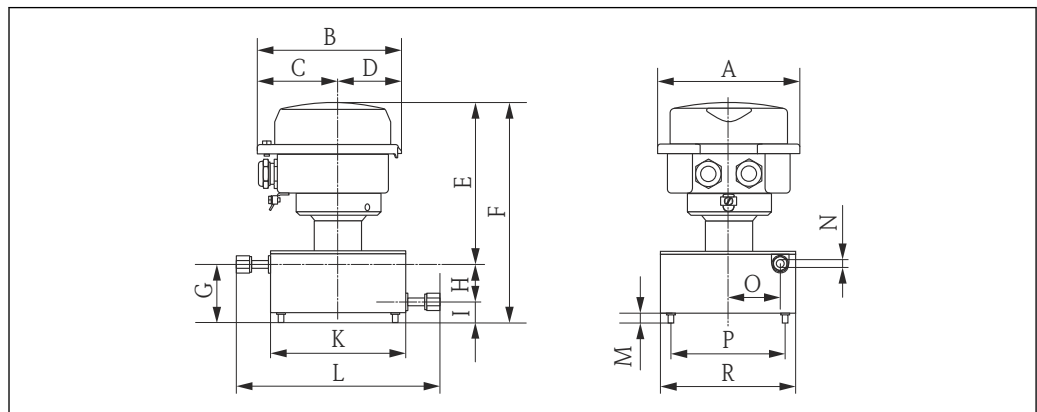

A0019432

DN [mm]	A [mm]	B [mm]	C [mm]	D [mm]	E <sup>1)</sup> [mm]	F <sup>1)</sup> [mm]	G [mm]	H [mm]
1	133.5	136.8	78	58.8	158	210	52	30
2	133.5	136.8	78	58.8	158	210	52	30
4	133.5	136.8	78	58.8	158	210	52	30
6	133.5	136.8	78	58.8	158	210	52	30

1) If using a display, order code for "Display; Operation", option B: values +14 mm

DN [mm]	I [mm]	K [mm]	L [mm]	M [mm]	N [mm]	O [mm]	P [mm]	R [mm]
1	22	120	175	10	1.3	40	90	120
2	22	120	175	10	2	40	90	120
4	22	120	175	10	3.9	40	90	120
6	22	120	175	10	5.35	40	90	120

Order code for "Housing", option C "Ultra-compact hygienic, stainless"

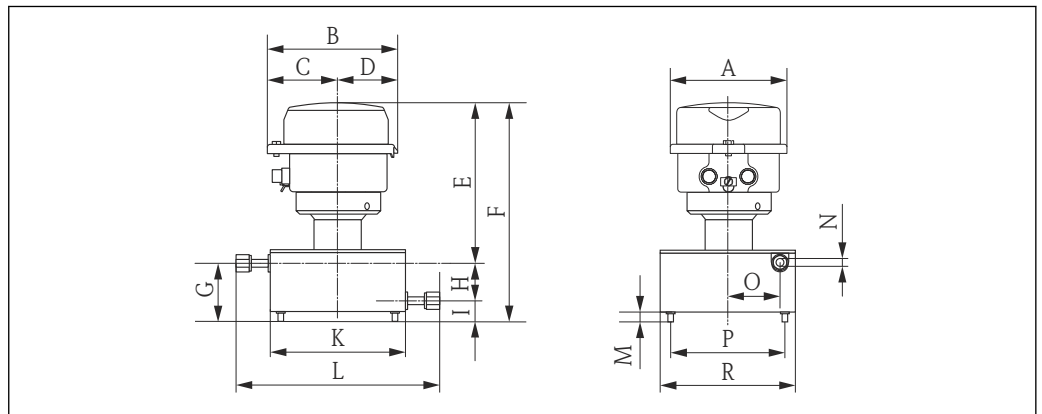

A0019433

DN [mm]	A [mm]	B [mm]	C [mm]	D [mm]	E <sup>1)</sup> [mm]	F <sup>1)</sup> [mm]	G [mm]	H [mm]
1	111.4	123.6	67.7	55.9	157	209	52	30
2	111.4	123.6	67.7	55.9	157	209	52	30
4	111.4	123.6	67.7	55.9	157	209	52	30
6	111.4	123.6	67.7	55.9	157	209	52	30

1) If using a display, order code for "Display; Operation", option B: values +14 mm

DN [mm]	I [mm]	K [mm]	L [mm]	M [mm]	N [mm]	O [mm]	P [mm]	R [mm]
1	22	120	175	10	1.3	40	90	120
2	22	120	175	10	2	40	90	120
4	22	120	175	10	3.9	40	90	120
6	22	120	175	10	5.35	40	90	120

**Threaded glands**

VCO coupling

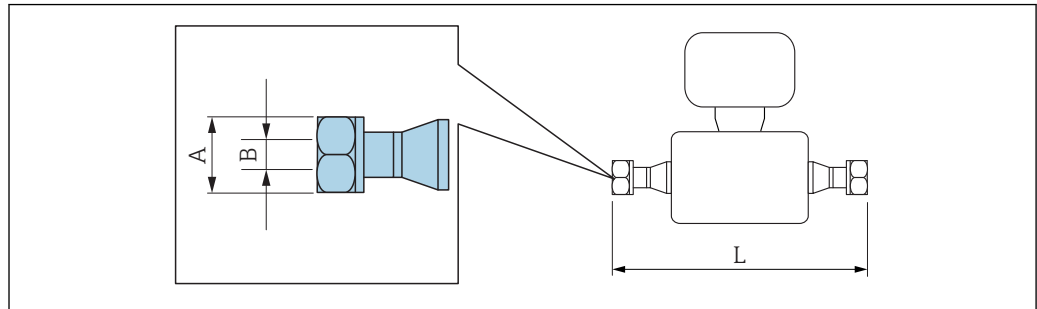

A0015624

28 Engineering unit mm (in)

4-VCO-4 1.4539 (904L): order code for "Process connection", option HAW			
DN [mm]	A [in]	B [mm]	L [mm]
1	1 <sup>1</sup> / <sub>16</sub>	12.5	175
2	1 <sup>1</sup> / <sub>16</sub>	12.5	175
4	1 <sup>1</sup> / <sub>16</sub>	12.5	175

8-VCO-4 1.4404 (316/316L): order code for "Process connection", option CVS			
DN [mm]	A [in]	B [mm]	L [mm]
6	1	20	175

**Adapter**

Adapter, DN 15 flange to VCO

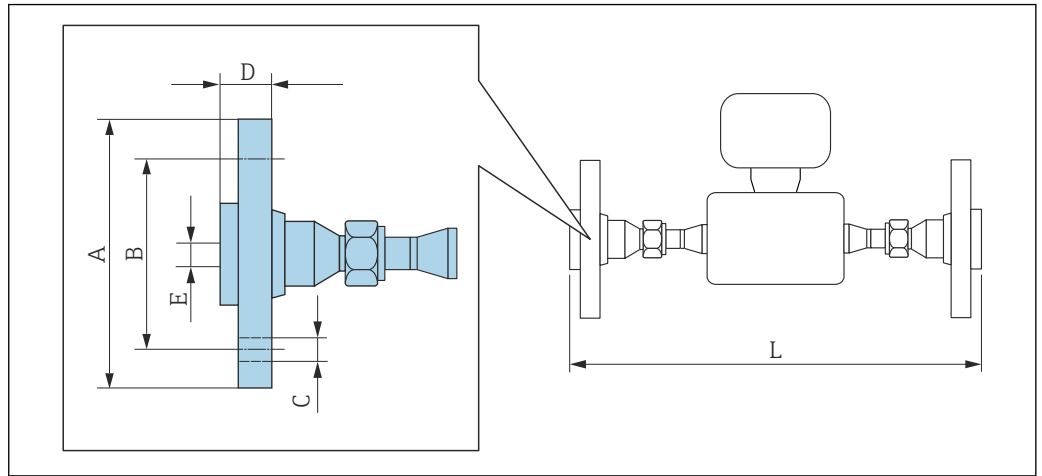

29 Engineering unit mm (in)

Adapter, DN 15 flange according to EN 1092-1 (DIN 2501): PN 40 1.4539 (904L): order code for "Accessories", option PE						
DN [mm]	A [mm]	B [mm]	C [mm]	D [mm]	E [mm]	L [mm]
1 to 6	95	65	4 × Ø14	28	17.3	278
DN 1 to 4 with 4-VCO-4, DN 6 with 8-VCO-4 Lap joint flanges (not wetted) made of stainless steel 1.4404 (316/316L) Sealing sets: order code for "Accessory enclosed", option <b>P1</b> (Viton), <b>P2</b> (EPDM), <b>P3</b> (silicone), <b>P4</b> (Kalrez)						

Adapter, flange according to ASME B16.5: Class 150 1.4539 (904L): order code for "Accessories", option PF						
DN [mm]	A [mm]	B [mm]	C [mm]	D [mm]	E [mm]	L [mm]
1 to 6	90.0	60.3	4 × Ø15.7	17.7	15.7	278
DN 1 to 4 with 4-VCO-4, DN 6 with 8-VCO-4 Lap joint flanges (not wetted) made of stainless steel 1.4404 (316/316L) Sealing sets: order code for "Accessory enclosed", option <b>P1</b> (Viton), <b>P2</b> (EPDM), <b>P3</b> (silicone), <b>P4</b> (Kalrez)						

Adapter, flange according to ASME B16.5: Class 300 1.4539 (904L): order code for "Accessories", option PG						
DN [mm]	A [mm]	B [mm]	C [mm]	D [mm]	E [mm]	L [mm]
1 to 6	95.0	60.3	4 × Ø15.7	20.7	15.7	278
DN 1 to 4 with 4-VCO-4, DN 6 with 8-VCO-4 Lap joint flanges (not wetted) made of stainless steel 1.4404 (316/316L) Sealing sets: order code for "Accessory enclosed", option <b>P1</b> (Viton), <b>P2</b> (EPDM), <b>P3</b> (silicone), <b>P4</b> (Kalrez)						

Adapter, JIS B2220 flange: 10K 1.4539 (904L): order code for "Accessories", option PH						
DN [mm]	A [mm]	B [mm]	C [mm]	D [mm]	E [mm]	L [mm]
1 to 6	95	70	4 × Ø15	28	15.0	278
DN 1 to 4 with 4-VCO-4, DN 6 with 8-VCO-4 Lap joint flanges (not wetted) made of stainless steel 1.4404 (316/316L) Sealing sets: order code for "Accessory enclosed", option <b>P1</b> (Viton), <b>P2</b> (EPDM), <b>P3</b> (silicone), <b>P4</b> (Kalrez)						



Adapter, NPTF to VCO

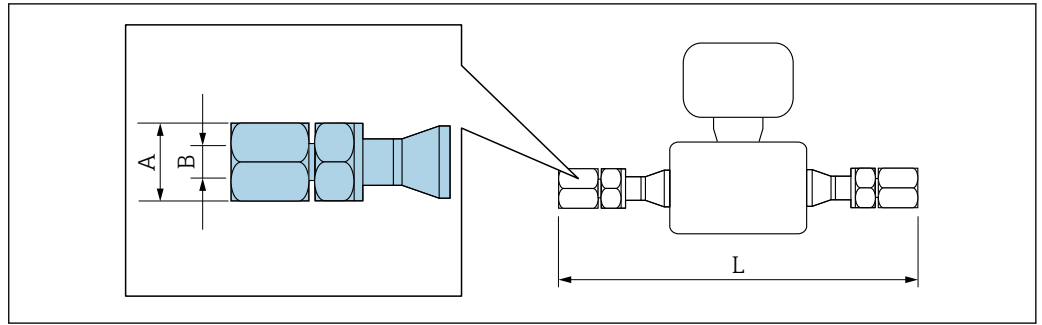

A0019724

30 Engineering unit mm (in)

Adapter, 1/4" NPTF to 4-VCO-4 1.4539 (904L): order code for "Accessories", option PC			
DN [mm]	A [in]	B [in]	L [mm]
1-4	3/4	1/4 NPT	246
Sealing sets: order code for "Accessory enclosed", option P1 (Viton), P2 (EPDM), P3 (silicone), P4 (Kalrez)			

Adapter, 1/4" NPTF to 8-VCO-4 1.4539 (904L): order code for "Accessories", option PD			
DN [mm]	A [in]	B [in]	L [mm]
6	11/16	1/2 NPT	246
Sealing sets: order code for "Accessory enclosed", option P1 (Viton), P2 (EPDM), P3 (silicone), P4 (Kalrez)			

Safety Barrier Promass 100

Top-hat rail EN 60715:

- TH 35 x 7.5
- TH 35 x 15

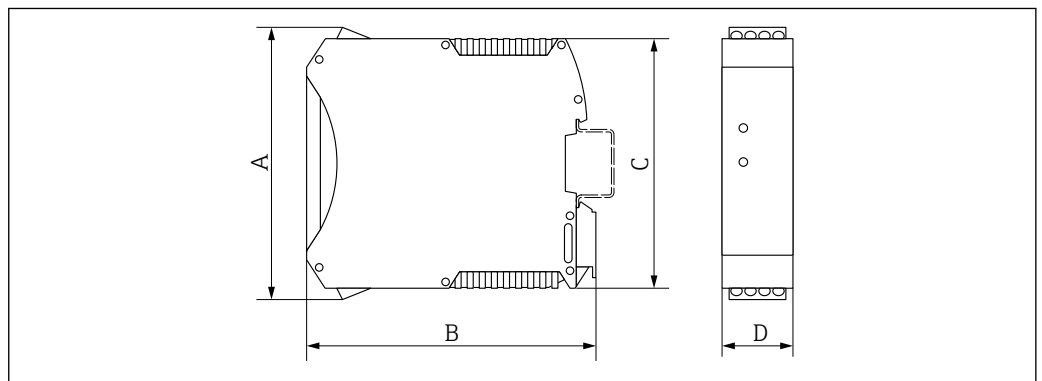

A0016777

A [mm]	B [mm]	C [mm]	D [mm]
108	114.5	99	22.5

Accessories

Dimensions in US units

Compact version

Order code for "Housing", option A "Compact coated alu"

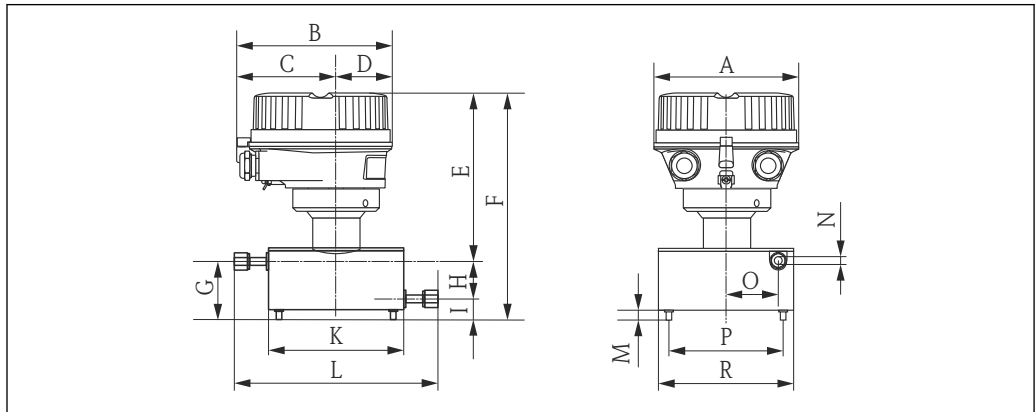

A0019431

DN [in]	A [in]	B [in]	C [in]	D [in]	E <sup>1)</sup> [in]	F <sup>1)</sup> [in]	G [in]	H [in]
1/24	5.35	5.81	3.68	2.13	6.38	8.43	2.05	1.18
1/12	5.35	5.81	3.68	2.13	6.38	8.43	2.05	1.18
1/8	5.35	5.81	3.68	2.13	6.38	8.43	2.05	1.18
1/4	5.35	5.81	3.68	2.13	6.38	8.43	2.05	1.18

1) If using a display, order code for "Display; operation", option B: values +1.1 in

DN [in]	I [in]	K [in]	L [in]	M [in]	N [in]	O [in]	P [in]	R [in]
1/24	0.87	4.72	6.89	0.39	0.051	1.57	3.54	4.72
1/12	0.87	4.72	6.89	0.39	0.08	1.57	3.54	4.72
1/8	0.87	4.72	6.89	0.39	0.15	1.57	3.54	4.72
1/4	0.87	4.72	6.89	0.39	0.21	1.57	3.54	4.72

Order code for "Housing", option B "Compact hygienic, stainless"

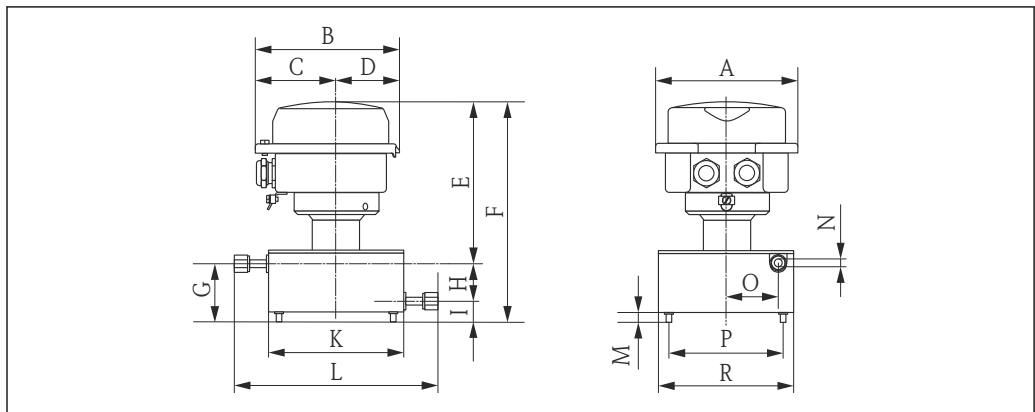

A0019432

DN [in]	A [in]	B [in]	C [in]	D [in]	E <sup>1)</sup> [in]	F <sup>1)</sup> [in]	G [in]	H [in]
1/24	5.26	5.39	3.07	2.31	6.22	8.27	2.05	1.18
1/12	5.26	5.39	3.07	2.31	6.22	8.27	2.05	1.18
1/8	5.26	5.39	3.07	2.31	6.22	8.27	2.05	1.18
1/4	5.26	5.39	3.07	2.31	6.22	8.27	2.05	1.18

1) If using a display, order code for "Display; operation", option B: values +0.55 in

DN [in]	I [in]	K [in]	L [in]	M [in]	N [in]	O [in]	P [in]	R [in]
1/24	0.87	4.72	6.89	0.39	0.051	1.57	3.54	4.72
1/12	0.87	4.72	6.89	0.39	0.08	1.57	3.54	4.72
1/8	0.87	4.72	6.89	0.39	0.15	1.57	3.54	4.72
1/4	0.87	4.72	6.89	0.39	0.21	1.57	3.54	4.72

Order code for "Housing", option C "Ultra-compact hygienic, stainless"

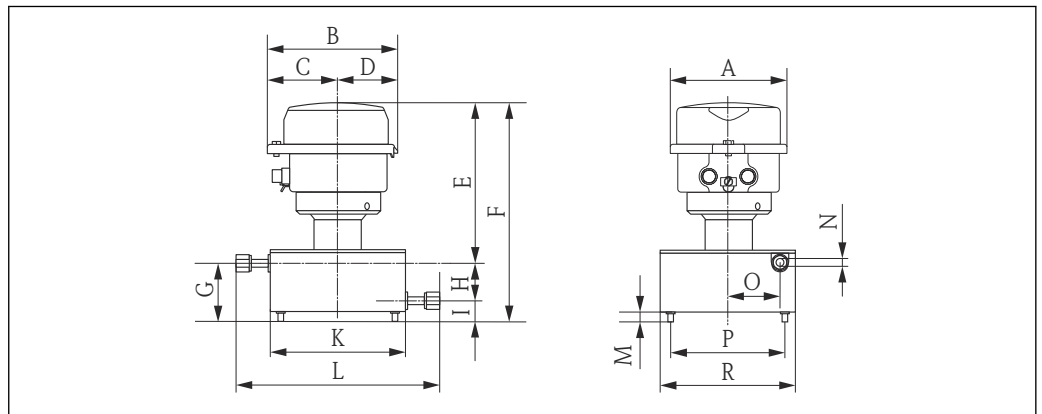

A0019433

DN	A [in]	B [in]	C [in]	D [in]	E <sup>1)</sup> [in]	F <sup>1)</sup> [in]	G [in]	H [in]
1/24	4.39	4.87	2.67	2.2	6.18	8.23	2.05	1.18
1/12	4.39	4.87	2.67	2.2	6.18	8.23	2.05	1.18
1/8	4.39	4.87	2.67	2.2	6.18	8.23	2.05	1.18
1/4	4.39	4.87	2.67	2.2	6.18	8.23	2.05	1.18

1) If using a display, order code for "Display; operation", option B: values +0.55 in

DN [in]	I [in]	K [in]	L [in]	M [in]	N [in]	O [in]	P [in]	R [in]
1/24	0.87	4.72	6.89	0.39	0.051	1.57	3.54	4.72
1/12	0.87	4.72	6.89	0.39	0.08	1.57	3.54	4.72
1/8	0.87	4.72	6.89	0.39	0.15	1.57	3.54	4.72
1/4	0.87	4.72	6.89	0.39	0.21	1.57	3.54	4.72

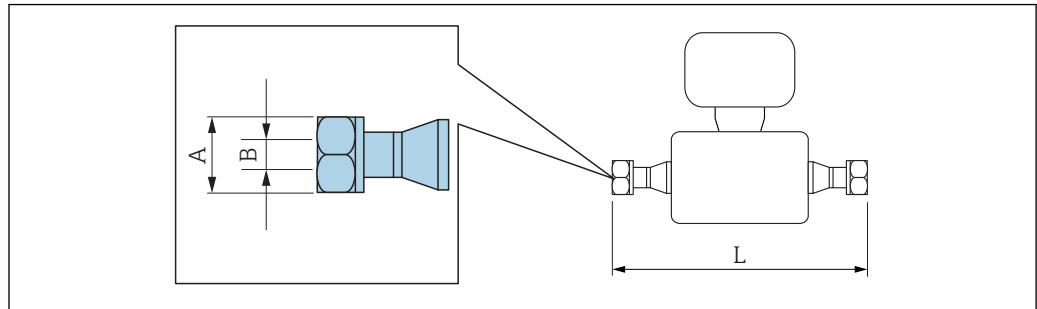
**Threaded glands***VCO coupling*

A0015624

31 Engineering unit mm (in)

**4-VCO-4**

1.4539 (904L): order code for "Process connection", option HAW

DN [mm]	A [in]	B [in]	L [in]
$\frac{1}{24}$	$\frac{11}{16}$	0.49	6.89
$\frac{1}{12}$	$\frac{11}{16}$	0.49	6.89
$\frac{1}{8}$	$\frac{11}{16}$	0.49	6.89

**8-VCO-4**

1.4404 (316/316L): order code for "Process connection", option CVS

DN [mm]	A [in]	B [in]	L [in]
$\frac{1}{4}$	1	0.79	6.89

**Adapter**

Adapter, DN 15 flange to VCO

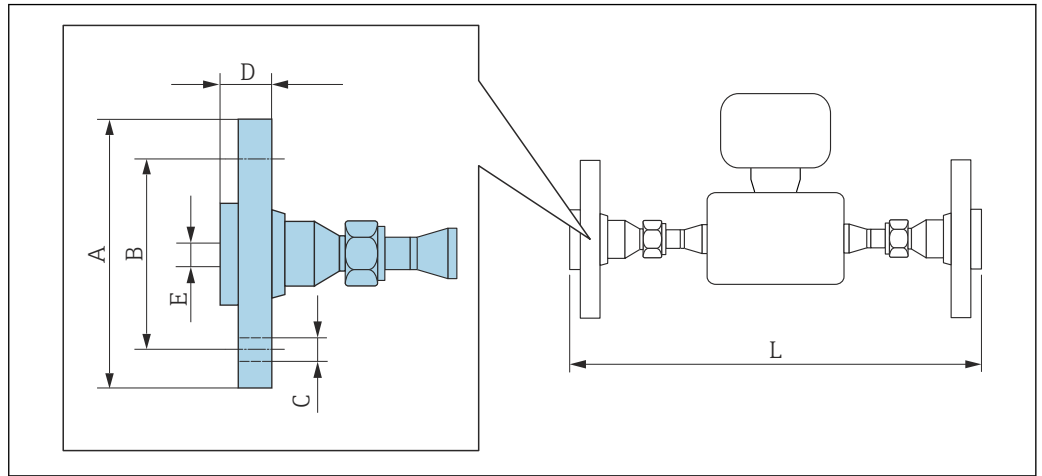

A0019725

32 Engineering unit mm (in)

<b>Adapter, flange according to ASME B16.5: Class 150</b>						
1.4539 (904L): order code for "Accessories", option PF						
DN [in]	A [in]	B [in]	C [in]	D [in]	E [in]	L [in]
1/24 to 1/4	3.54	2.37	4 × Ø0.62	0.7	0.62	10.94
DN 1/24 to 1/8 with 4-VCO-4, DN 1/4 with 8-VCO-4 Lap joint flanges (not wetted) made of stainless steel 1.4404 (316/316L) Sealing sets: order code for "Accessory enclosed", option P1 (Viton), P2 (EPDM), P3 (silicone), P4 (Kalrez)						

<b>Adapter, flange according to ASME B16.5: Class 300</b>						
1.4539 (904L): order code for "Accessories", option PG						
DN [in]	A [in]	B [in]	C [in]	D [in]	E [in]	L [in]
1/24 to 1/4	3.74	2.37	4 × Ø0.62	0.81	0.62	10.94
DN 1/24 to 1/8 with 4-VCO-4, DN 1/4 with 8-VCO-4 Lap joint flanges (not wetted) made of stainless steel 1.4404 (316/316L) Sealing sets: order code for "Accessory enclosed", option P1 (Viton), P2 (EPDM), P3 (silicone), P4 (Kalrez)						

Adapter, NPTF to VCO

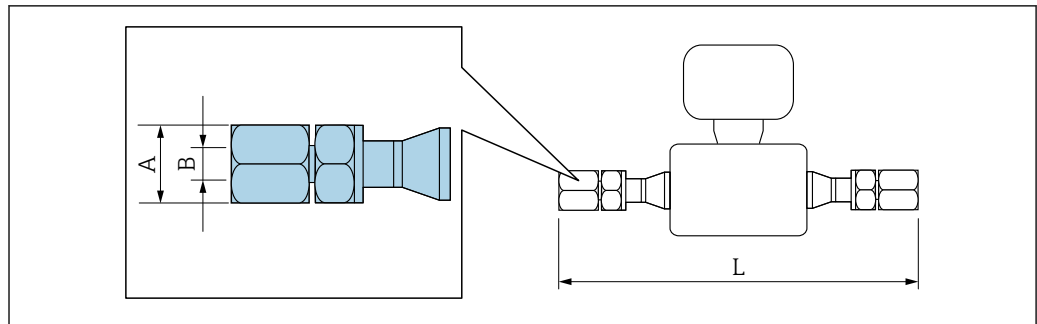

A0019724

33 Engineering unit mm (in)

Adapter, 1/4" NPTF to 4-VCO-4 1.4539 (904L): order code for "Accessories", option PC			
DN [mm]	A [in]	B [in]	L [in]
1/24 to 1/8	3/4	1/4 NPT	9.69
Sealing sets: order code for "Accessory enclosed", option P1 (Viton), P2 (EPDM), P3 (silicone), P4 (Kalrez)			

Adapter, 1/4" NPTF to 8-VCO-4 1.4539 (904L): order code for "Accessories", option PD			
DN [mm]	A [in]	B [in]	L [in]
1/4	11/16	1/2 NPT	9.69
Sealing sets: order code for "Accessory enclosed", option P1 (Viton), P2 (EPDM), P3 (silicone), P4 (Kalrez)			

Safety Barrier Promass 100

Top-hat rail EN 60715:

- TH 35 x 7.5
- TH 35 x 15

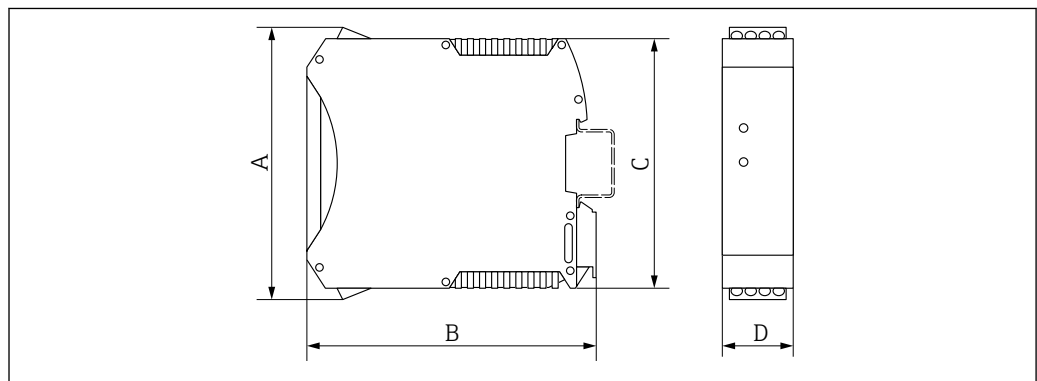

A0016777

A [in]	B [in]	C [in]	D [in]
4.25	4.51	3.9	0.89

Accessories

**Weight**

All values (weight exclusive of packaging material) refer to devices with VCO couplings. Weight specifications including transmitter: order code for "Housing", option A "Compact, aluminum coated".

**Weight in SI units**

DN [mm]	Weight [kg]
1 to 6	3.5

**Weight in US units**

DN [in]	Weight [lbs]
1/24 to 1/4	8

**Safety Barrier Promass 100**

49 g (1.73 ounce)

**Materials**

**Transmitter housing**

- Order code for "Housing", option **A** "Compact, aluminum coated": Aluminum, AlSi10Mg, coated
- Order code for "Housing", option **B** "Compact, hygienic, stainless": Hygienic version, stainless steel 1.4301 (304)
- Order code for "Housing", option **C** "Ultra-compact, hygienic, stainless": Hygienic version, stainless steel 1.4301 (304)
- Window material for optional local display (→ 65):
  - For order code for "Housing", option **A**: glass
  - For order code for "Housing", option **B** and **C**: plastic

**Cable entries/cable glands**

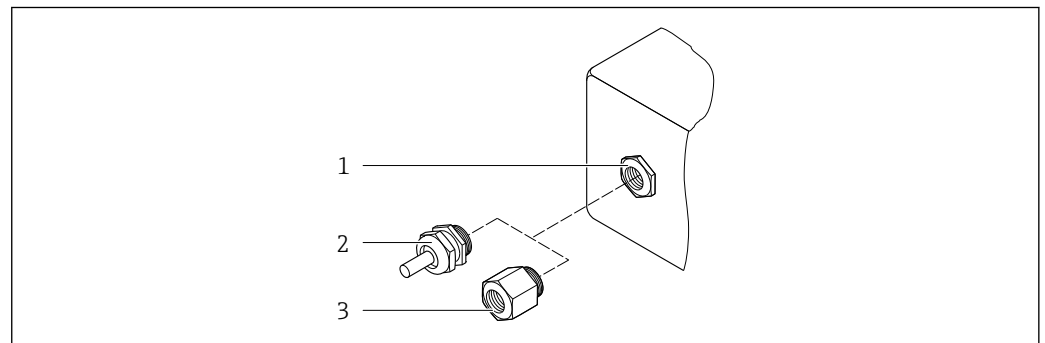

34 Possible cable entries/cable glands

- 1 Female thread M20 × 1.5
- 2 Cable gland M20 × 1.5
- 3 Adapter for cable entry with female thread G 1/2" or NPT 1/2"

Order code for "Housing", option A "Compact, aluminum, coated"

The various cable entries are suitable for hazardous and non-hazardous areas.

Cable entry/cable gland	Material
Cable gland M20 × 1.5	Nickel-plated brass
Adapter for cable entry with female thread G 1/2"	
Adapter for cable entry with female thread NPT 1/2"	

Order code for "Housing", option B "Compact, hygienic, stainless"

The various cable entries are suitable for hazardous and non-hazardous areas.

Cable entry/cable gland	Material
Cable gland M20 × 1.5	Stainless steel, 1.4404 (316L)
Adapter for cable entry with female thread G ½"	
Adapter for cable entry with female thread NPT ½"	

### Device plug

Electrical connection	Material
Plug M12x1	<ul style="list-style-type: none"> <li>■ Socket: Stainless steel, 1.4404 (316L)</li> <li>■ Contact housing: Polyamide</li> <li>■ Contacts: Gold-plated brass</li> </ul>

### Sensor housing

- Acid and alkali-resistant outer surface
- Stainless steel 1.4301 (304)

### Measuring tubes

Stainless steel, 1.4539 (904L)

### Process connections

VCO connection:



VCO connection: stainless steel, 1.4539 (904L)

Adapter for DN 15 flange according to EN 1092-1 (DIN2501) / according to ASME B 16.5 / as per JIS B2220:

Stainless steel, 1.4539 (904L)

NPTF adapter:

Stainless steel, 1.4539 (904L)

 Available process connections →  65

### Seals

Welded process connections without internal seals

### Seals for mounting kit

- Viton
- EPDM
- Silicone
- Kalrez

### Accessories

*Protective cover*

Stainless steel, 1.4404 (316L)

*Safety Barrier Promass 100*

Housing: Polyamide



**Process connections**

- Fixed flange connections:
  - EN 1092-1 (DIN 2512N) flange
  - ASME B16.5 flange
  - JIS B2220 flange
- VCO connections:
  - 4-VCO-4
  - 8-VCO-4
- Adapter for VCO connections:
  - Flange EN 1092-1 (DIN 2501)
  - Flange ASME B16.5
  - Flange JIS B2220
  - NPT

 Process connection materials

**Surface roughness**

All data relate to parts in contact with fluid. The following surface roughness quality can be ordered.  
Not polished

## Human interface

**Operating concept**

**Operator-oriented menu structure for user-specific tasks**

- Commissioning
- Operation
- Diagnostics
- Expert level

**Quick and safe commissioning**

- Individual menus for applications
- Menu guidance with brief explanations of the individual parameter functions

**Reliable operation**

- Operation in the following languages:
  - Via "FieldCare", "DeviceCare" operating tool:  
English, German, French, Spanish, Italian, Chinese, Japanese
  - Via integrated Web browser (only available for device versions with HART, PROFIBUS DP, PROFINET and EtherNet/IP):  
English, German, French, Spanish, Italian, Dutch, Portuguese, Polish, Russian, Turkish, Chinese, Japanese, Bahasa (Indonesian), Vietnamese, Czech, Swedish, Korean
- Uniform operating philosophy applied to operating tools and Web browser
- If replacing the electronic module, transfer the device configuration via the plug-in memory (HistoROM DAT) which contains the process and measuring device data and the event logbook. No need to reconfigure.  
For devices with Modbus RS485, the data recovery function is implemented without the plug-in memory (HistoROM DAT).

**Efficient diagnostics increase measurement availability**

- Troubleshooting measures can be called up via the operating tools and web browser
- Diverse simulation options
- Status indicated by several light emitting diodes (LEDs) on the electronic module in the housing compartment

**Local display**

 A local display is only available for device versions with the following communication protocols:  
HART, PROFIBUS-DP, PROFINET, EtherNet/IP

The local display is only available with the following device order code:  
Order code for "Display; operation", option **B**: 4-line; illuminated, via communication

**Display element**

- 4-line liquid crystal display with 16 characters per line.
- White background lighting; switches to red in event of device errors.
- Format for displaying measured variables and status variables can be individually configured.
- Permitted ambient temperature for the display: -20 to +60 °C (-4 to +140 °F). The readability of the display may be impaired at temperatures outside the temperature range.

## Remote operation

## Via HART protocol

This communication interface is available in device versions with a HART output.

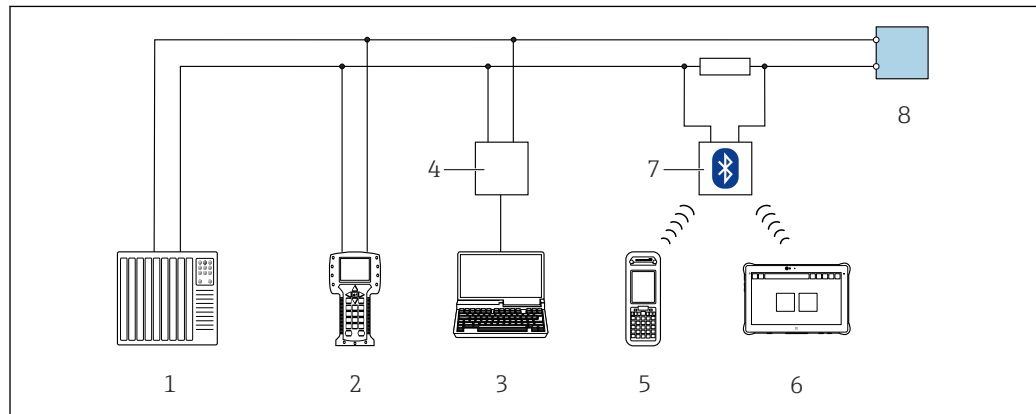

A0028747

35 Options for remote operation via HART protocol

- 1 Control system (e.g. PLC)
- 2 Field Communicator 475
- 3 Computer with operating tool (e.g. FieldCare, AMS Device Manager, SIMATIC PDM)
- 4 Commubox FXA195 (USB)
- 5 Field Xpert SFX350 or SFX370
- 6 Field Xpert SMT70
- 7 VIATOR Bluetooth modem with connecting cable
- 8 Transmitter

## Via PROFIBUS DP network

This communication interface is available in device versions with PROFIBUS DP.

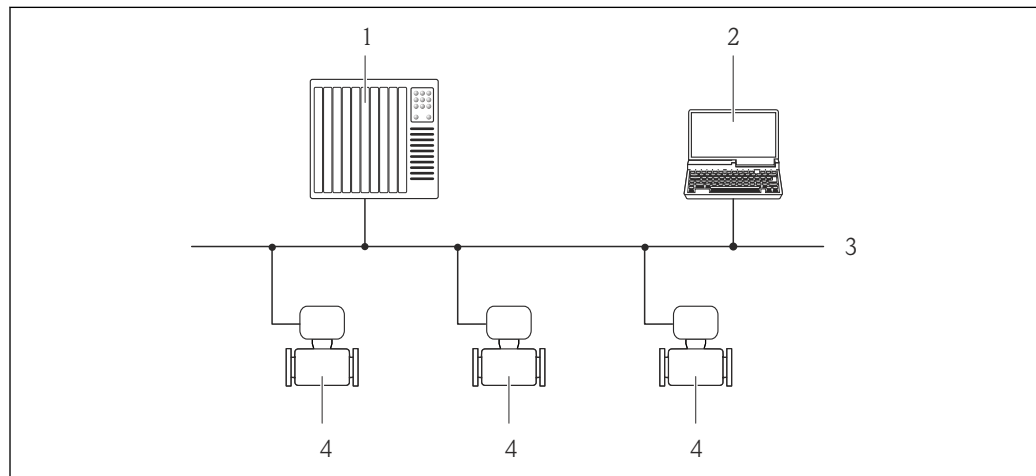

A0020903

36 Options for remote operation via PROFIBUS DP network

- 1 Automation system
- 2 Computer with PROFIBUS network card
- 3 PROFIBUS DP network
- 4 Measuring device

## Via EtherNet/IP network

This communication interface is available in device versions with EtherNet/IP.

Star topology

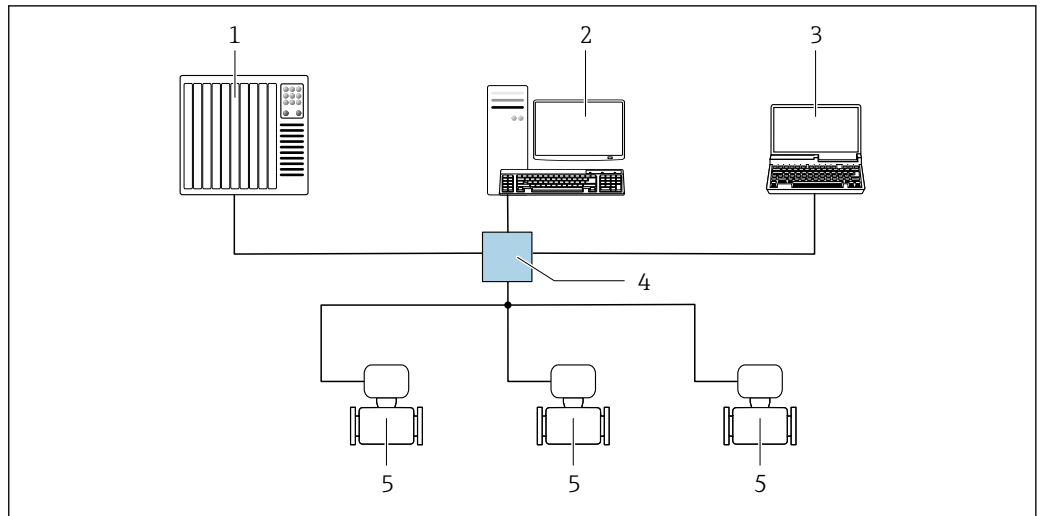

A0032078

37 Options for remote operation via EtherNet/IP network: star topology

- 1 Automation system, e.g. "RSLogix" (Rockwell Automation)
- 2 Workstation for measuring device operation: with Custom Add-On Profile for "RSLogix 5000" (Rockwell Automation) or with Electronic Data Sheet (EDS)
- 3 Computer with Web browser (e.g. Internet Explorer) for accessing the integrated device Web server or computer with operating tool (e.g. FieldCare, DeviceCare) with COM DTM "CDI Communication TCP/IP"
- 4 Ethernet switch
- 5 Measuring device

Via PROFINET network

This communication interface is available in device versions with PROFINET.

Star topology

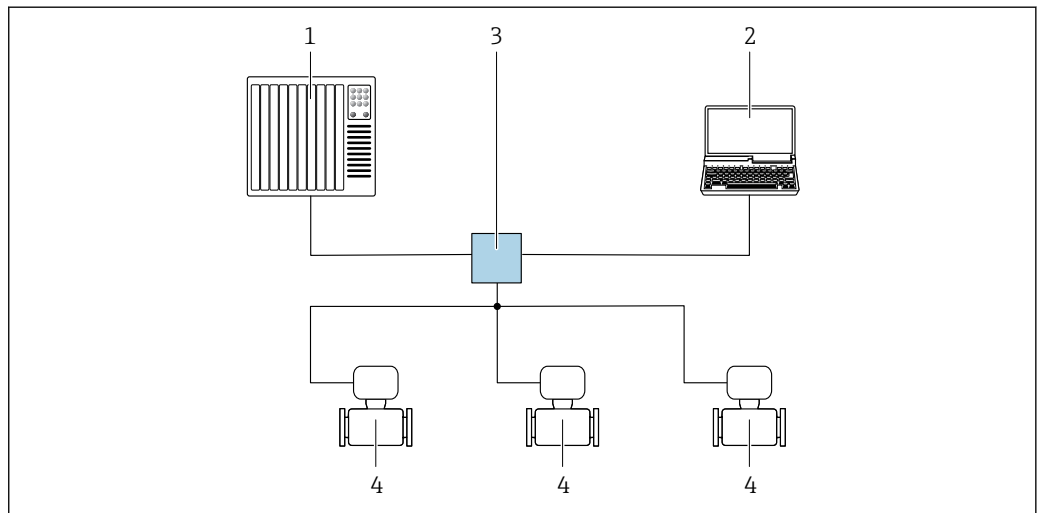

A0026545

38 Options for remote operation via PROFINET network: star topology

- 1 Automation system, e.g. Simatic S7 (Siemens)
- 2 Computer with Web browser (e.g. Internet Explorer) for accessing the integrated device Web server or computer with operating tool (e.g. FieldCare, DeviceCare, SIMATIC PDM) with COM DTM "CDI Communication TCP/IP"
- 3 Switch, e.g. Scalance X204 (Siemens)
- 4 Measuring device

## Service interface

## Via service interface (CDI-RJ45)

This communication interface is present in the following device version:

- Order code for "Output", option **B**: 4-20 mA HART, pulse/frequency/switch output
- Order code for "Output", option **L**: PROFIBUS DP
- Order code for "Output", option **N**: EtherNet/IP
- Order code for "Output", option **R**: PROFINET

## HART

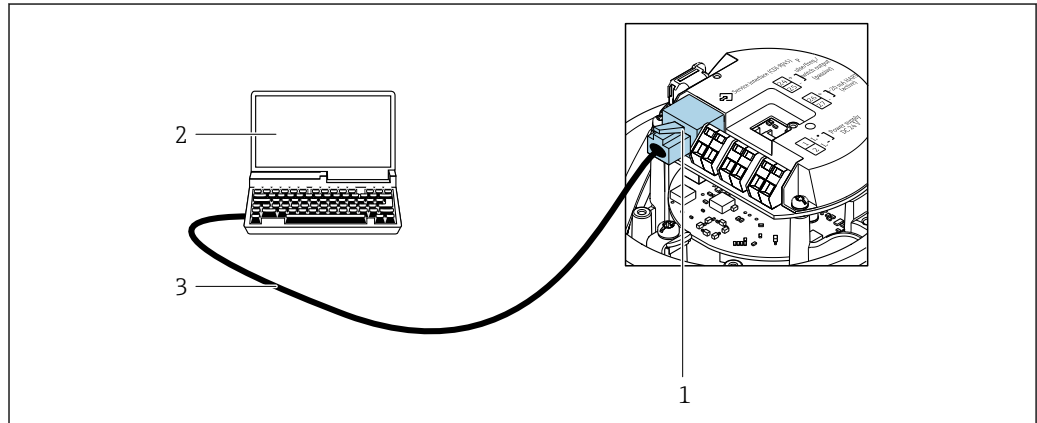

A0016926

39 Connection for the order code for "Output", option B: 4-20 mA HART, pulse/frequency/switch output

- 1 Service interface (CDI -RJ45) of the measuring device with access to the integrated Web server
- 2 Computer with Web browser (e.g. Internet Explorer) for accessing the integrated device Web server or with "FieldCare" operating tool with COM DTM "CDI Communication TCP/IP"
- 3 Standard Ethernet connecting cable with RJ45 plug

## PROFIBUS DP

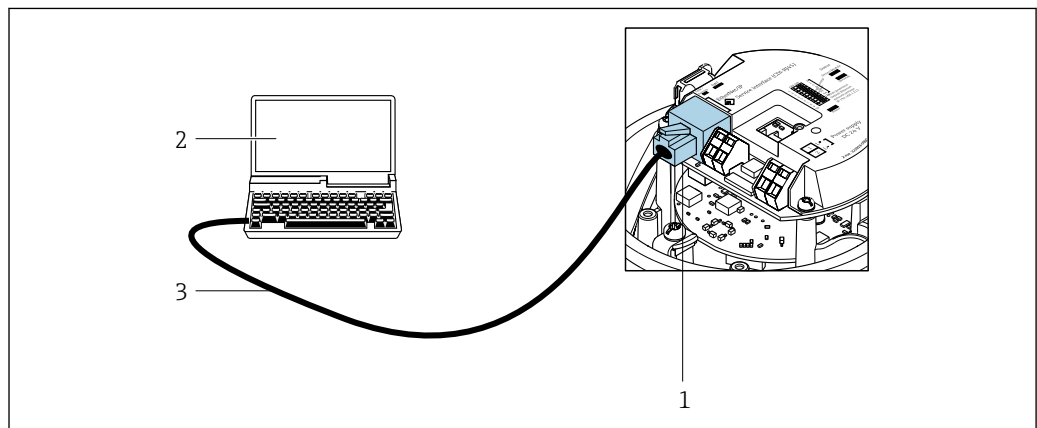

A0021270

40 Connection for order code for "Output", option L: PROFIBUS DP

- 1 Service interface (CDI -RJ45) of the measuring device with access to the integrated Web server
- 2 Computer with Web browser (e.g. Internet Explorer) for accessing the integrated device Web server or with "FieldCare" operating tool with COM DTM "CDI Communication TCP/IP"
- 3 Standard Ethernet connecting cable with RJ45 plug

*EtherNet/IP*

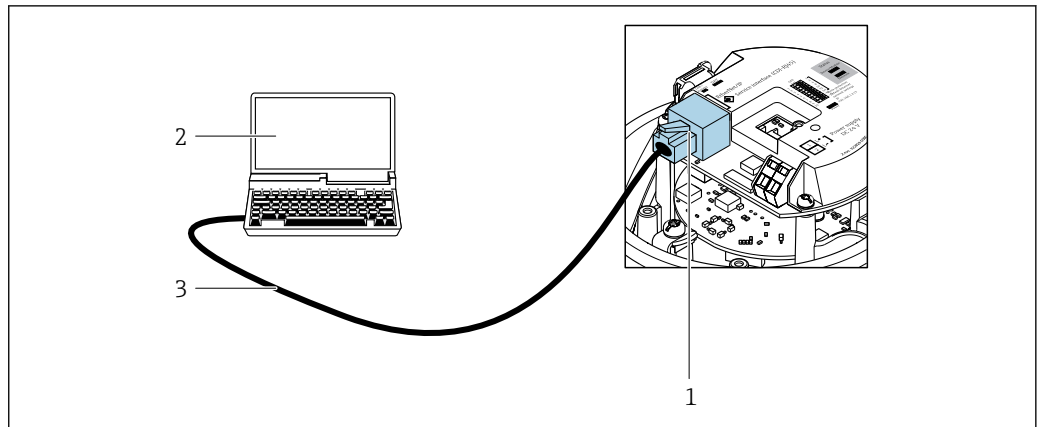

A0016940

41 Connection for order code for "Output", option N: EtherNet/IP

- 1 Service interface (CDI -RJ45) and EtherNet/IP interface of the measuring device with access to the integrated Web server
- 2 Computer with Web browser (e.g. Internet Explorer) for accessing the integrated device Web server or with "FieldCare" operating tool with COM DTM "CDI Communication TCP/IP"
- 3 Standard Ethernet connecting cable with RJ45 plug

*PROFINET*

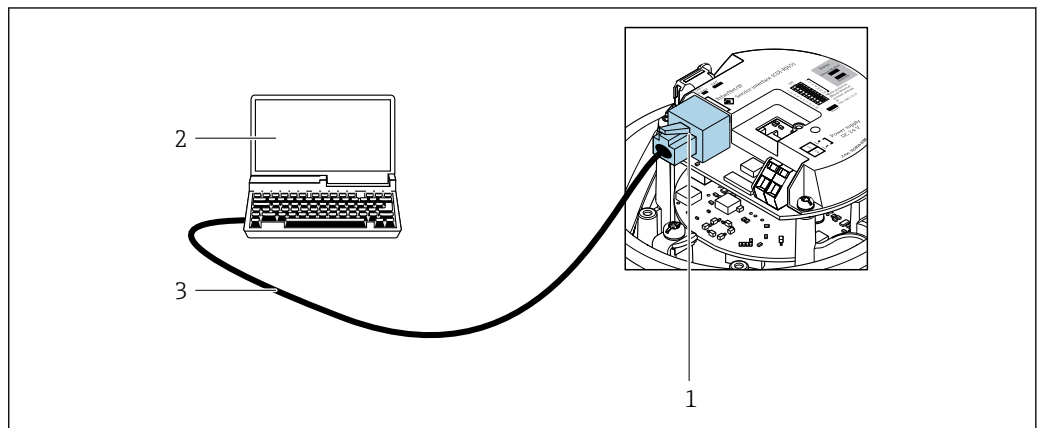

A0016940

42 Connection for order code for "Output", option R: PROFINET

- 1 Service interface (CDI -RJ45) and PROFINET interface of the measuring device with access to the integrated Web server
- 2 Computer with Web browser (e.g. Internet Explorer) for accessing the integrated device Web server or with "FieldCare" operating tool with COM DTM "CDI Communication TCP/IP"
- 3 Standard Ethernet connecting cable with RJ45 plug

**Via service interface (CDI)**

This communication interface is present in the following device version:  
Order code for "Output", option **M**: Modbus RS485

## Modbus RS485

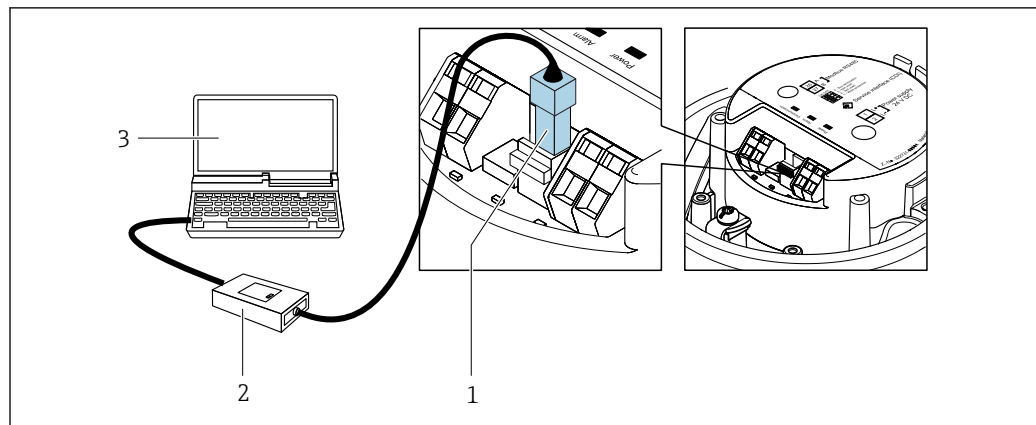

A0030216

- 1 Service interface (CDI) of measuring device
- 2 Commubox FXA291
- 3 Computer with "FieldCare" operating tool with "CDI Communication FXA291" COM DTM

## Certificates and approvals



Currently available certificates and approvals can be called up via the product configurator.

### CE mark

The device meets the legal requirements of the applicable EU Directives. These are listed in the corresponding EU Declaration of Conformity along with the standards applied.

Endress+Hauser confirms successful testing of the device by affixing to it the CE mark.

### RCM-tick symbol

The measuring system meets the EMC requirements of the "Australian Communications and Media Authority (ACMA)".

### Pressure Equipment Directive

- With the identification PED/G1/x (x = category) on the sensor nameplate, Endress+Hauser confirms conformity with the "Essential Safety Requirements" specified in Appendix I of the Pressure Equipment Directive 2014/68/EU.
- Devices bearing this marking (PED) are suitable for the following types of medium:
  - Media in Group 1 and 2 with a vapor pressure greater than, or smaller and equal to 0.5 bar (7.3 psi)
  - Unstable gases
- Devices not bearing this marking (PED) are designed and manufactured according to good engineering practice. They meet the requirements of Article 4 paragraph 3 of the Pressure Equipment Directive 2014/68/EU. The range of application is indicated in tables 6 to 9 in Annex II of the Pressure Equipment Directive 2014/68/EU.

### Other standards and guidelines

- EN 60529  
Degrees of protection provided by enclosures (IP code)
- IEC/EN 60068-2-6  
Environmental influences: Test procedure - Test Fc: vibrate (sinusoidal).
- IEC/EN 60068-2-31  
Environmental influences: Test procedure - Test Ec: shocks due to rough handling, primarily for devices.
- EN 61010-1  
Safety requirements for electrical equipment for measurement, control and laboratory use - general requirements
- IEC/EN 61326  
Emission in accordance with Class A requirements. Electromagnetic compatibility (EMC requirements).
- NAMUR NE 21  
Electromagnetic compatibility (EMC) of industrial process and laboratory control equipment

- NAMUR NE 32  
Data retention in the event of a power failure in field and control instruments with microprocessors
- NAMUR NE 43  
Standardization of the signal level for the breakdown information of digital transmitters with analog output signal.
- NAMUR NE 53  
Software of field devices and signal-processing devices with digital electronics
- NAMUR NE 105  
Specifications for integrating fieldbus devices in engineering tools for field devices
- NAMUR NE 107  
Self-monitoring and diagnosis of field devices
- NAMUR NE 131  
Requirements for field devices for standard applications
- NAMUR NE 132  
Coriolis mass meter

## Ordering information

Detailed ordering information is available as follows:

- In the Product Configurator on the Endress+Hauser website: [www.endress.com](http://www.endress.com) -> Click "Corporate" -> Select your country -> Click "Products" -> Select the product using the filters and search field -> Open product page -> The "Configure" button to the right of the product image opens the Product Configurator.
- From your Endress+Hauser Sales Center: [www.addresses.endress.com](http://www.addresses.endress.com)



### **Product Configurator - the tool for individual product configuration**

- Up-to-the-minute configuration data
- Depending on the device: Direct input of measuring point-specific information such as measuring range or operating language
- Automatic verification of exclusion criteria
- Automatic creation of the order code and its breakdown in PDF or Excel output format
- Ability to order directly in the Endress+Hauser Online Shop

## Application packages

Many different application packages are available to enhance the functionality of the device. Such packages might be needed to address safety aspects or specific application requirements.

The application packages can be ordered with the device or subsequently from Endress+Hauser. Detailed information on the order code in question is available from your local Endress+Hauser sales center or on the product page of the Endress+Hauser website: [www.endress.com](http://www.endress.com).



Detailed information on the application packages:  
Special Documentation for the device →  75

**Heartbeat Technology**

Package	Description
Heartbeat Verification +Monitoring	<p><b>Heartbeat Verification</b> Meets the requirement for traceable verification to DIN ISO 9001:2008 Chapter 7.6 a) "Control of monitoring and measuring equipment".</p> <ul style="list-style-type: none"> <li>■ Functional testing in the installed state without interrupting the process.</li> <li>■ Traceable verification results on request, including a report.</li> <li>■ Simple testing process via local operation or other operating interfaces.</li> <li>■ Clear measuring point assessment (pass/fail) with high test coverage within the framework of manufacturer specifications.</li> <li>■ Extension of calibration intervals according to operator's risk assessment.</li> </ul> <p><b>Heartbeat Monitoring</b> Continuously supplies data, which are characteristic of the measuring principle, to an external condition monitoring system for the purpose of preventive maintenance or process analysis. These data enable the operator to:</p> <ul style="list-style-type: none"> <li>■ Draw conclusions - using these data and other information - about the impact process influences (such as corrosion, abrasion, buildup etc.) have on the measuring performance over time.</li> <li>■ Schedule servicing in time.</li> <li>■ Monitor the process or product quality, e.g. gas pockets.</li> </ul>

**Concentration**

Package	Description
Concentration	<p><b>Calculation and outputting of fluid concentrations</b> The measured density is converted to the concentration of a substance of a binary mixture using the "Concentration" application package:</p> <ul style="list-style-type: none"> <li>■ Choice of predefined fluids (e.g. various sugar solutions, acids, alkalis, salts, ethanol etc.)</li> <li>■ Common or user-defined units ("Brix, °Plato, % mass, % volume, mol/l etc.) for standard applications.</li> <li>■ Concentration calculation from user-defined tables.</li> </ul> <p>The measured values are output via the digital and analog outputs of the device.</p>



**Special density**

Package	Description
Special density	<p>Many applications use density as a key measured value for monitoring quality or controlling processes. The device measures the density of the fluid as standard and makes this value available to the control system. The "Special Density" application package offers high-precision density measurement over a wide density and temperature range particularly for applications subject to varying process conditions.</p>













## Accessories

Various accessories, which can be ordered with the device or subsequently from Endress+Hauser, are available for the device. Detailed information on the order code in question is available from your local Endress+Hauser sales center or on the product page of the Endress+Hauser website: [www.endress.com](http://www.endress.com).







**Device-specific accessories****Communication-specific accessories**



Accessories	Description
Commubox FXA195 HART	<p>For intrinsically safe HART communication with FieldCare via the USB interface.</p>  Technical Information TI00404F
Commubox FXA291	<p>Connects Endress+Hauser field devices with a CDI interface (= Endress+Hauser Common Data Interface) and the USB port of a computer or laptop.</p>  Technical Information TI405C/07





HART Loop Converter HMX50	<p>Is used to evaluate and convert dynamic HART process variables to analog current signals or limit values.</p> <ul style="list-style-type: none"> <li> Technical Information TI00429F</li> <li> Operating Instructions BA00371F</li> </ul>
Wireless HART adapter SWA70	<p>Is used for the wireless connection of field devices. The WirelessHART adapter can be easily integrated into field devices and existing infrastructures, offers data protection and transmission safety and can be operated in parallel with other wireless networks with minimum cabling complexity.</p> <ul style="list-style-type: none"> <li> Operating Instructions BA00061S</li> </ul>
Fieldgate FXA42	<p>Is used to transmit the measured values of connected 4 to 20 mA analog measuring devices, as well as digital measuring devices</p> <ul style="list-style-type: none"> <li> Technical Information TI01297S</li> <li> Operating Instructions BA01778S</li> <li> Product page: <a href="http://www.endress.com/fxa42">www.endress.com/fxa42</a></li> </ul>
Field Xpert SMT70	<p>The Field Xpert SMT70 tablet PC for device configuration enables mobile plant asset management in hazardous and non-hazardous areas. It is suitable for commissioning and maintenance staff to manage field instruments with a digital communication interface and to record progress. This tablet PC is designed as an all-in-one solution with a preinstalled driver library and is an easy-to-use, touch-sensitive tool which can be used to manage field instruments throughout their entire life cycle.</p> <ul style="list-style-type: none"> <li> Technical Information TI01342S</li> <li> Operating Instructions BA01709S</li> <li> Product page: <a href="http://www.endress.com/smt70">www.endress.com/smt70</a></li> </ul>
Field Xpert SMT77	<p>The Field Xpert SMT77 tablet PC for device configuration enables mobile plant asset management in areas categorized as Ex Zone 1.</p> <ul style="list-style-type: none"> <li> Technical Information TI01418S</li> <li> Operating Instructions BA01923S</li> <li> Product page: <a href="http://www.endress.com/smt77">www.endress.com/smt77</a></li> </ul>

**Service-specific accessories**

Accessories	Description
Applicator	<p>Software for selecting and sizing Endress+Hauser measuring devices:</p> <ul style="list-style-type: none"> <li> Choice of measuring devices for industrial requirements</li> <li> Calculation of all the necessary data for identifying the optimum flowmeter: e.g. nominal diameter, pressure loss, flow velocity and accuracy.</li> <li> Graphic illustration of the calculation results</li> <li> Determination of the partial order code, administration, documentation and access to all project-related data and parameters over the entire life cycle of a project.</li> </ul> <p>Applicator is available:</p> <ul style="list-style-type: none"> <li> Via the Internet: <a href="https://portal.endress.com/webapp/applicator">https://portal.endress.com/webapp/applicator</a></li> <li> As a downloadable DVD for local PC installation.</li> </ul>
W@M	<p>W@M Life Cycle Management</p> <p>Improved productivity with information at your fingertips. Data relevant to a plant and its components is generated from the first stages of planning and during the asset's complete life cycle.</p> <p>W@M Life Cycle Management is an open and flexible information platform with online and on-site tools. Instant access for your staff to current, in-depth data shortens your plant's engineering time, speeds up procurement processes and increases plant uptime.</p> <p>Combined with the right services, W@M Life Cycle Management boosts productivity in every phase. For more information, visit <a href="http://www.endress.com/lifecyclemanagement">www.endress.com/lifecyclemanagement</a></p>

Accessories	Description
FieldCare	FDT-based plant asset management tool from Endress+Hauser. It can configure all smart field units in your system and helps you manage them. By using the status information, it is also a simple but effective way of checking their status and condition.  Operating Instructions BA00027S and BA00059S
DeviceCare	Tool to connect and configure Endress+Hauser field devices.  Innovation brochure IN01047S

**System components**

Accessories	Description
Memograph M graphic data manager	The Memograph M graphic data manager provides information on all the relevant measured variables. Measured values are recorded correctly, limit values are monitored and measuring points analyzed. The data are stored in the 256 MB internal memory and also on a SD card or USB stick.  <ul style="list-style-type: none"> <li>▪ Technical Information TI00133R</li> <li>▪ Operating Instructions BA00247R</li> </ul>
iTEMP	The temperature transmitters can be used in all applications and are suitable for the measurement of gases, steam and liquids. They can be used to read in the medium temperature.  "Fields of Activity" document FA00006T

## Supplementary documentation

-  For an overview of the scope of the associated Technical Documentation, refer to the following:
- *W@M Device Viewer* ([www.endress.com/deviceviewer](http://www.endress.com/deviceviewer)): Enter the serial number from nameplate
  - *Endress+Hauser Operations App*: Enter the serial number from the nameplate or scan the 2D matrix code (QR code) on the nameplate

**Standard documentation      Brief Operating Instructions***Brief Operating Instructions for the sensor*

Measuring device	Documentation code
Proline Cubemass C	KA01217D

*Transmitter Brief Operating Instructions*

Measuring device	Documentation code
Proline Promass 100	KA01334D KA01333D KA01335D KA01332D KA01336D

**Technical Information**

Measuring device	Documentation code
Cubemass C 100	TI01105D

**Description of Device Parameters**

Measuring device	Documentation code
Cubemass 100	GP01063D
Cubemass 100	GP01064D
Cubemass 100	GP01065D
Cubemass 100	GP01066D
Cubemass 100	GP01067D

**Supplementary device-dependent documentation****Safety Instructions**

Content	Documentation code
ATEX/IECEX Ex i	XA01030D
ATEX/IECEX Ex nA	XA01143D
cCSAus IS	XA01142D
INMETRO Ex i	XA01221D
INMETRO Ex nA	XA01222D
NEPSI Ex i	XA01261D
NEPSI Ex nA	XA01263D

**Special Documentation**

Content	Documentation code
Information on the Pressure Equipment Directive	SD00142D
Modbus RS485 Register Information	SD00154D
Concentration measurement	SD01152D
Heartbeat Technology	SD01153D
Heartbeat Technology	SD01493D
Web server	SD01820D
Web server	SD01821D
Web server	SD01822D
Web server	SD01823D

**Installation Instructions**

Contents	Comment
Installation instructions for spare part sets and accessories	Documentation code: specified for each individual accessory → 72.

**Registered trademarks****HART®**

Registered trademark of the HART Communication Foundation, Austin, USA

**PROFIBUS®**

Registered trademark of the PROFIBUS User Organization, Karlsruhe, Germany

**Modbus®**

Registered trademark of SCHNEIDER AUTOMATION, INC.

**EtherNet/IP™**

Trademark of ODVA, Inc.

**PROFINET®**

Registered trademark of the PROFIBUS User Organization, Karlsruhe, Germany

**Microsoft®**

Registered trademark of the Microsoft Corporation, Redmond, Washington, USA

**TRI-CLAMP®**

Registered trademark of Ladish & Co., Inc., Kenosha, USA

**Applicator®, FieldCare®, DeviceCare®, Field Xpert™, HistoROM®, Heartbeat Technology™**

Registered or registration-pending trademarks of the Endress+Hauser Group

[www.addresses.endress.com](http://www.addresses.endress.com)

---